

BOWMAN®



Dispensers



PPE DISPENSING SOLUTIONS FOR EVERY MARKET

Healthcare | Food Service | Industrial | Dental | & Beyond

2016 CATALOG

Table of Contents

- Alternate Uses** 74
- Bulk Dispensers** 54
- Construction and Renovation** 4
 - Dispenser Reference Checklist 10
- Face Mask Dispensers** 46
- Glove Box Dispensers** 36
- Hand Hygiene Dispensing Systems** 34
- Index** 78
- Material and Color Information** 76
- Protection Systems** 14
- Respiratory Hygiene Stations** 28
- Specialty Dispensers** 60
 - Bag Dispensers 68
 - Bed Pan & Urinal Dispenser 70
 - Disposable Wipe Dispenser 71
 - Industrial, Food Service, Dental & Educational Dispensers 72
 - Sterile Procedure Area Dispensers 60
- Signature Series** 12



Product Number Guide Example

PS016-0212 = Protection System, Model 016, ABS, Quartz Beige

TYPE	MODEL	COLOR	MATERIAL
PS	016	02	12

BOWMAN Materials ¹			BOWMAN Colors ¹		
<ul style="list-style-type: none"> (ABS) ABS Plastic 02 (AFP) ABS Fauxwood Plastic 02 (ALM) Aluminum 05 	<ul style="list-style-type: none"> (CRS) Cold Rolled Steel 04 (PET) PETG Plastic 01 (PLC) Polycarbonate Plastic 12 	<ul style="list-style-type: none"> (STP) Sintra® Plastic 07 (STS) Stainless Steel 03 (WIR) Powder-Coated Wire 06 	<ul style="list-style-type: none"> (29) Bay Gray 29 (20) Black 20 (33) Cherry 33 	<ul style="list-style-type: none"> (11) Clear 11 (14) Frosted Clear 14 (23) Maple 23 	<ul style="list-style-type: none"> (12) Quartz Beige 12 (00) Stainless Steel 00 (13, 34) White 13, 34

BOWMAN DISPENSING & STORAGE SOLUTIONS
Adaptable to any setting where PPE is required

¹ See page 76 for extended material and color information. Colors may vary. Not all colors or materials are available for all dispensers. Use the material codes shown in this catalog as a reference for what a particular dispenser is made from. Custom options are also available. Call BOWMAN or check with your distributor if you have questions.



EARLY PLANNING LEADS TO SUCCESSFUL BUDGETING, SCHEDULING, AND ON-TIME DELIVERY

Infection control policies have shaped healthcare design, making PPE dispensing an essential aspect of any construction or remodeling project. To deliver your project on time and under budget, early planning is critical.

The BOWMAN Dispenser line contains an extensive selection of PPE dispensing solutions to meet a wide range of design, budget and material applications, in both stocked and custom designed offerings.

BOWMAN offers custom design and manufacturing services for dispensing solutions on walls, recessed in walls, or inside cabinet mounting applications if a stocked dispenser is not applicable for your project.

5 OPTIONS TO FIT ANY PROJECT OR BUDGET

Select and order dispensers for your next project with ease. From stock designs to custom creations, BOWMAN has your needs in mind.



STOCK DESIGNS

Check out material & color options on page 76.

- ✓ Ready to install
- ✓ Variety of colors and materials
- ✓ Expedited shipping available
- ✓ Convenient for projects with a quick turn-around
- ✓ Preferred choice for standard locations

GET STARTED FAST

WITH OUR DISPENSER LOCATION CHECKLIST, LOCATED ON PAGES 10-11



NC001-0512 (ALM)
Bedpan/Urinal Dispenser



BP-090 (PET)
Bulk Dispenser - Tall Triple Bin



GL030-0223 (AFP)
Glove Box Dispenser - Triple with Dividers

2 INTERIOR CABINET MOUNTING

Did you know? BOWMAN offers custom designed products; see page 8 for more information.

- ✓ Interior cabinet mounting is available with select BOWMAN dispensers or custom designed products
- ✓ Great option for locations where a built-in look is preferred
- ✓ Keeps essentials tucked away and easy to access



GB-144 (CRS)
Glove Box Dispenser Single

GL300-1214 (PLC)
Glove Box Dispenser - Triple with Dividers



View A: Shown attached to the inside of a cabinet with precut glove dispenser holes



View B: Shown from outside the cabinet



View C: Shown in a dental office cabinet²

²Photo provided by Cabinet Plus, Inc.

3 RECESSED PPE DISPENSING UNITS

- ✓ Available through the BOWMAN Custom Design Program
- ✓ Variety of layout options available for Glove Dispensing, Flu Prep, and Protection Systems
- ✓ Great choice for high traffic areas such as hallways or near elevators



INQUIRE TODAY

BOWMAN team members are ready to facilitate your next planning project. Contact us at **800.962.4660** to learn more.



New **RE101-0012** (ALM)
Recessed PPE Dispensing System



New **RE301-0012** (ALM)
Recessed Glove Box Dispenser - Triple

4 CUSTOM DESIGNS

- ✓ Ideal for non-standard locations
- ✓ Private labeling option: add custom information such as company name or logo and up to three lines of text (See page 77 for more information)
- ✓ Minimum order quantity applies

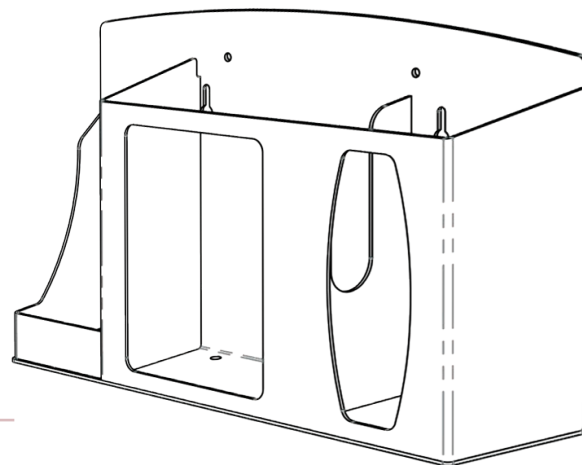
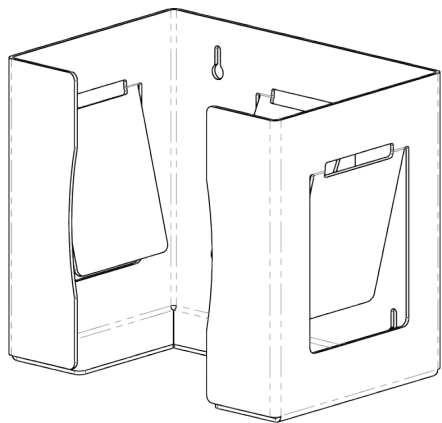

NEW DESIGN EXAMPLES

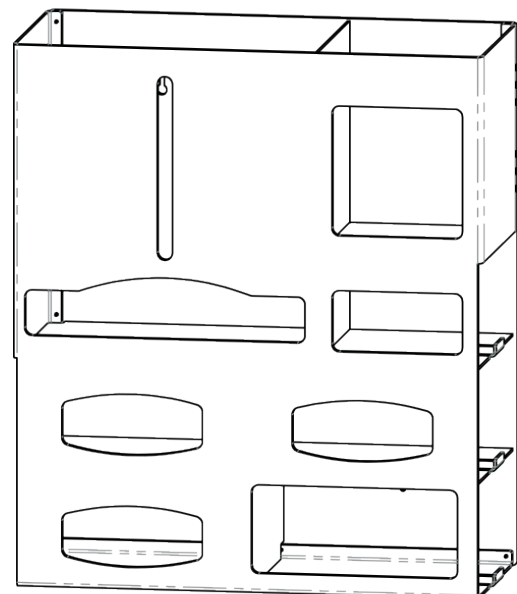
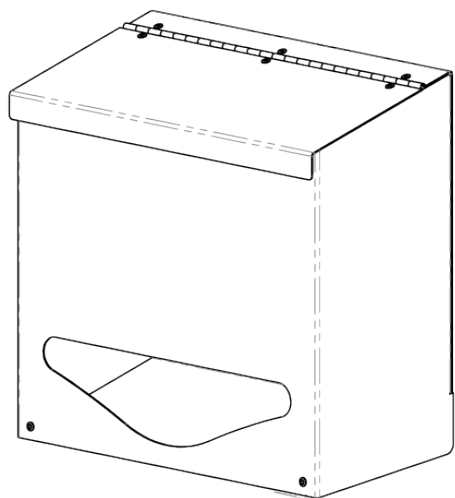

5 PALADIN RAIL SYSTEM



A POWERFUL PAIR

Many BOWMAN Dispensers can be combined with the Paladin Rail Equipment Management System, giving you the ultimate in versatility, adaptability and expandability for your current and future equipment management needs.



Step 1: GL030-0233 Empty
BOWMAN Glove Box Dispenser GL030-0233



Step 2: GL030-0233 & Bracket
Paladin Bracket Attachment on GL030-0233

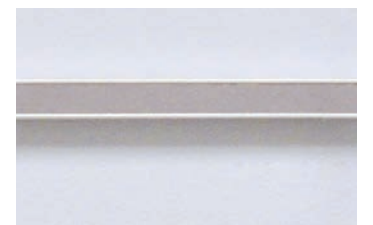

Step 3: Rail
Paladin Rail on wall



Step 4: Complete
GL030-0233 attached to Paladin Rail
Equipment Management System



Clinic Exam Room



For more information or to order BOWMAN Dispensers with the Paladin Rail Equipment Management System, please contact Paladin Healthcare at 407-614-8781 or visit them at www.PaladinHC.com

ORGANIZING DEPARTMENTS, HOSPITAL WIDE

Get started with our Dispenser Location Checklist

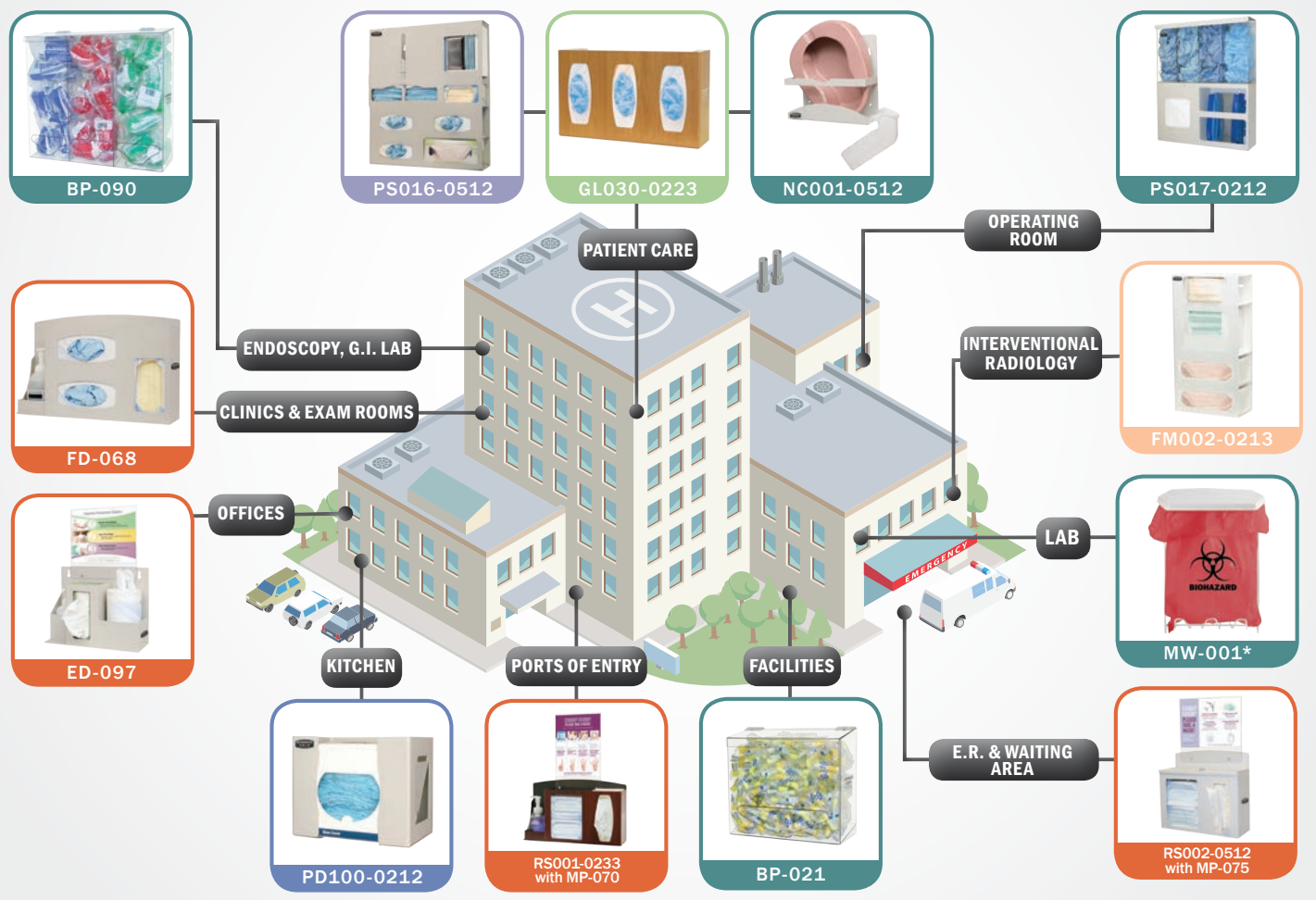

► Save Time and Resources by Securing the Products You Need in Advance:

PROTECTION SYSTEMS	LOCATION	✓	LOCATION	✓
PS016-0223 	All Patient Care Areas	<input type="checkbox"/>	Clinic Areas	<input type="checkbox"/>
	Emergency / Triage	<input type="checkbox"/>	Cath Labs	<input type="checkbox"/>
	Oncology for Isolation or Chemo Administration	<input type="checkbox"/>	O.R. Dressing Areas	<input type="checkbox"/>
	Lab Areas	<input type="checkbox"/>	Anywhere PPE Supplies are Used for Isolation and Staff / Patient Protection	<input type="checkbox"/>

RESPIRATORY HYGIENE STATIONS AND FLOOR STANDS	LOCATION	✓	LOCATION	✓
RS001-0512 <i>Shown w/ MP-070</i> 	All Ports of Entry	<input type="checkbox"/>	E.R. Waiting Room	<input type="checkbox"/>
	Any Patient Waiting Area	<input type="checkbox"/>	Physician Office Waiting Room	<input type="checkbox"/>
	Admission Waiting Room	<input type="checkbox"/>	Clinic Waiting Room	<input type="checkbox"/>
GLOVE DISPENSERS	LOCATION	✓	LOCATION	✓
GL040-0233 	All Patient Rooms	<input type="checkbox"/>	Physical Therapy	<input type="checkbox"/>
	All Clinical / Exam Rooms	<input type="checkbox"/>	Cath Labs	<input type="checkbox"/>
	Radiology / Inpatient and Outpatient	<input type="checkbox"/>	Endoscopy / GI Labs	<input type="checkbox"/>
	Kitchens	<input type="checkbox"/>	O.R. Areas / PAR	<input type="checkbox"/>
	Laundry Facilities	<input type="checkbox"/>	Employee Health	<input type="checkbox"/>
	Environmental Services	<input type="checkbox"/>	Anywhere Direct Patient Care Occurs	<input type="checkbox"/>
	Sterile Processing	<input type="checkbox"/>		
FACE MASK DISPENSERS	LOCATION	✓	LOCATION	✓
FM100-0212 	All Patient Rooms	<input type="checkbox"/>	Endoscopy / GI Labs	<input type="checkbox"/>
	Pediatrics	<input type="checkbox"/>	O.R. Areas / PAR	<input type="checkbox"/>
	ICU	<input type="checkbox"/>	Surgery Centers	<input type="checkbox"/>
	Emergency Departments	<input type="checkbox"/>	TB Clinics	<input type="checkbox"/>
	Cath Labs	<input type="checkbox"/>		
SPECIALTY STERILE PROCEDURE AREAS	LOCATION	✓	LOCATION	✓
BK002-0300 	O.R. / PAR - Caps, Shoe Covers & Other PPE	<input type="checkbox"/>	Cath Labs	<input type="checkbox"/>
	MRI / Facilities - Ear Plug Dispensing	<input type="checkbox"/>	Interventional Radiology	<input type="checkbox"/>
	Endoscopy / GI Labs	<input type="checkbox"/>	Surgery Centers	<input type="checkbox"/>
	Kitchen - Hair Coverage	<input type="checkbox"/>	Anywhere Sterile Procedures are Provided	<input type="checkbox"/>
SPECIALTY - OTHER	LOCATION	✓	LOCATION	✓
BG001-0512 	Patient Rooms for Waste / Linen / Garbage Disposal - BG001-0512	<input type="checkbox"/>	Anywhere booties and caps are used - PD100-0212	<input type="checkbox"/>
	All Patient Care Area Restrooms - NC001-0512	<input type="checkbox"/>	Lab - MW-001	<input type="checkbox"/>

* IMPORTED

All consumable items are for demonstration purposes only and are not available for purchase through BOWMAN®.

Protection Systems Choose from Cherry or Maple Fauxwood. (AFP)



PS016-0233



PS016-0223

Major Benefits

APPEARANCE

Our fauxwood material is engineered to have a natural grain appearance in both Cherry and Maple finishes. The two color choices provide a visually appealing, upscale option for any area.

PATIENT SATISFACTION

Patients demand quality care in a comfortable care setting. Integrate

the **BOWMAN Signature Series** fauxwood dispenser line to offer patients an at-home feel to their healthcare experience.

STRENGTH & DURABILITY

ABS plastic is chemical and stress-crack resistant. It is tough, dimensionally stable, and will hold up to long-term use. These qualities make it perfect for a wide variety of applications, including medical and laboratory equipment.

CLEANING

BOWMAN Signature Series products can be cleaned with standard hospital cleaning products.³

CUSTOMIZATION

Most dispensers can be made with Signature Series materials and color. Minimum order quantities may apply.

³Avoid using petroleum-based oils, solvents, and paints on Signature Series products.

Glove Box Dispensers Three-way keyholes for vertical or horizontal mounting.



GL010-0233
Also available in Maple



GL020-0223
Also available in Cherry



GL030-0233
Also available in Maple



GL040-0223
Also available in Cherry

Respiratory Hygiene Stations & Floor Stands



RS001-0233
Respiratory Hygiene Station
Optional sign holder (MP-070 shown, or MP-075) sold separately
Also available in Maple

KS010-0420 (CRS)
Floor Stand - Black
Also available in White



RS001-0223
Respiratory Hygiene Station
Optional sign holder (MP-070 shown, or MP-075) sold separately
Also available in Cherry

PATENT PENDING

VIOLATION

Corridor CLUTTER

is one of the TOP 10
costly JCAHO⁴ violations

**VIOLATION of
Life Safety Code
LS.02.01.20:
MAINTAIN THE INTEGRITY
OF THE MEANS OF EGRESS**

⁴The Joint Commission on Accreditation of Healthcare Organizations (JCAHO) is an organization which develops and maintains standards of quality in medical facilities in the United States.

Convenience and Accessibility

- BOWMAN Protection Systems provide a versatile option for standardizing the locations of Personal Protective Equipment (PPE) supplies in patient care areas.
- Protection Systems are utilized in high traffic, highly visible locations outside patient rooms.

Versatility

- **Permanent**- BOWMAN Protection Systems are designed to be used for standardization of location of protective equipment for everyday protection by placing units permanently on walls outside of patient rooms.
- **Dual Purpose**- When infection is identified, the isolation sign can be added to the wall unit, converting it into an isolation station.
- **Portable**- The Protection Systems can be hung intermittently on patient doors and are a cost effective adjunct to existing isolation carts.
- **Consumable Products**- The system is designed to fit consumable PPE products from most major manufacturers.
- **Easy Access**- The unit has no doors or drawers allowing for easy access and visualization of consumable products.

Safety

- **Clear Corridors**- Protection Systems provide organization of PPE supplies, reducing clutter in high traffic areas by mounting units on walls or doors located near patient rooms, eliminating the potential for blocking entry and exit ways.
- **Visible Cue**- Supplies are highly visible to staff and visitors, improving compliance with isolation policies related to PPE donning, thereby decreasing the potential for costly HAI's (Healthcare Associated Infections).

Cost Effectiveness

- BOWMAN Protection Systems provide the same level of protection as isolation carts at a fraction of the cost.
- Save time and money during the restocking process by having the PPE dispensing areas visible without doors or drawers to block the view.

Education

- Essential Infection Control signage can be added to the BOWMAN Protection System to ensure proper isolation is initiated and maintained.
- BOWMAN offers free isolation signs on our website www.BowmanDispensers.com

The BOWMAN Protection System SOLUTION



PS016-0512 

Protection System

Optional sign holder
(MP-047 shown) sold separately

Storage Area Options



Miscellaneous Medical Supplies



Boxed Face Masks



4th Box of Gloves



Miscellaneous Wipes

The BOWMAN PS016 Protection System

120 customizable CURES for clutter

Gown Options



Laundered Gowns



2 Boxes of Thumb Loop Gowns



2 Stacks of Thumb Loop Gowns



Flat Pack Gowns



2 Packs of Overhead Cover Gowns

- Proven design
- Available in multiple color & material options
- Mounts on doors or walls
- Holds most major manufacturers' PPE consumable products
- Made in the USA

Material / Color Options



PS016-0111 Clear PETG Plastic



PS016-0212 Quartz Beige ABS Plastic



PS016-0223 Maple Fauxwood ABS Plastic



PS016-0233 Cherry Fauxwood ABS Plastic



New Material PS016-0300 Stainless Steel



PS016-0512 Quartz Beige Aluminum

Accessories



Narrow
LD-064 (ABS)

Compact
FM002-0213 (ABS)
White



New Material

Double Gown
PS015-0512 (ALM)
Also available - PS015-0212 (ABS)



New Material
The Original
PS021-0512 (ALM)
Also available - LD-007 (ABS)



New Material
Double Glove
PS022-0512 (ALM)
Also available - LD-037 (ABS)



MP-015 (PET)
Large Caddy
Dispenser
Clip-On
Shown on
PS016-0223



MP-085 (PET)
Caddy
Dispenser
Clip-On
Shown on
PS016-0233



MP-047 (PET)
Vertical
Sign Holder
Clip-On
Shown on
PS016-0512

**ACCESSORIES
FIT MOST
BOWMAN
PROTECTION
SYSTEMS**

Reference pages 24-25
for product specs

PREVENT COSTLY OUTBREAK INVESTIGATIONS

Arm frontline staff with the tools necessary to isolate potentially infected patients upon arrival

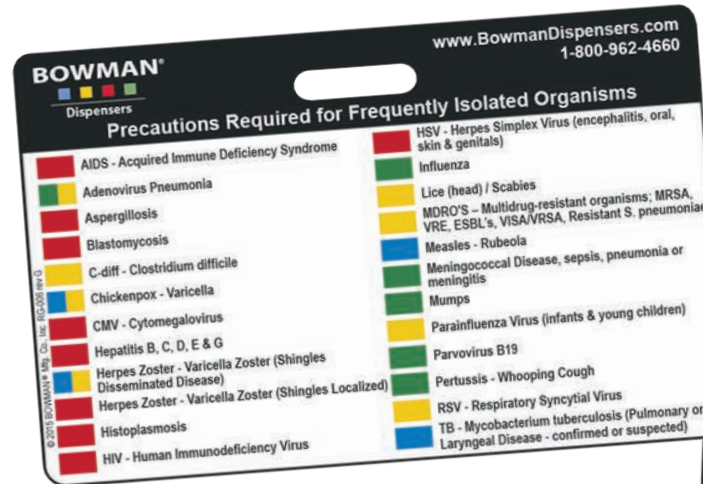

Transmission Based Precautions Quick Reference Guide*
*Ref. HICPAC/CDC Guidelines, 2007

Hand Hygiene Before & After Patient Contact

	Standard	Contact	Droplet	Airborne
Clinical Situation	All patients	MDRO's - Resistant organisms; Diarrhea; Draining wounds	Upper Respiratory Infections; including unknown infections prior to organism ID	Tuberculosis - Pulmonary or Laryngeal Disease, confirmed or suspected; Chickenpox or Measles
Room Preference	Private or semi-private	Private. Consult Infection Control (IC) for co-horting	Private. Consult Infection Control (IC) for co-horting. Separate patients by 3 ft	Private. AIR negative airflow, door closed
Wear Gloves	Contact w/ blood, body fluids, or potentially contaminated material	Wear gloves upon entering room	Same as standard precautions	Same as standard precautions
Wear a Mask	Contact w/ blood, body fluids, or potential sprays of respiratory secretions	Same as standard precautions	Wear a mask upon entering room	Wear an N-95 mask or higher level respirator
Wear a Gown	Contact w/ blood, body fluids, or potentially contaminated material	Wear a gown upon entering room	Same as standard precautions	Same as standard precautions

Transmission Based Precautions Quick Reference Guide*
*Ref. HICPAC/CDC Guidelines, 2007

Hand Hygiene Before & After Patient Contact

	Standard	Contact	Droplet	Airborne
Clinical Situation	All patients	MDRO's - Resistant organisms; Diarrhea; Draining wounds	Upper Respiratory Infections; including unknown infections prior to organism ID	Tuberculosis - Pulmonary or Laryngeal Disease confirmed or suspected; Chickenpox or Measles
Room Preference	Private or semi-private	Private. Consult Infection Control (IC) for co-horting	Private. Consult Infection Control (IC) for co-horting. Separate patients by 3 ft	Private. AIR negative airflow, door closed
Wear Gloves	Contact w/ blood, body fluids, or potentially contaminated material	Wear gloves upon entering room	Same as standard precautions	Same as standard precautions
Wear a Mask	Contact w/ blood, body fluids, or potential sprays of respiratory secretions	Same as standard precautions	Wear a mask upon entering room	Wear an N-95 mask or higher level respirator
Wear a Gown	Contact w/ blood, body fluids, or potentially contaminated material	Wear a gown upon entering room	Same as standard precautions	Same as standard precautions

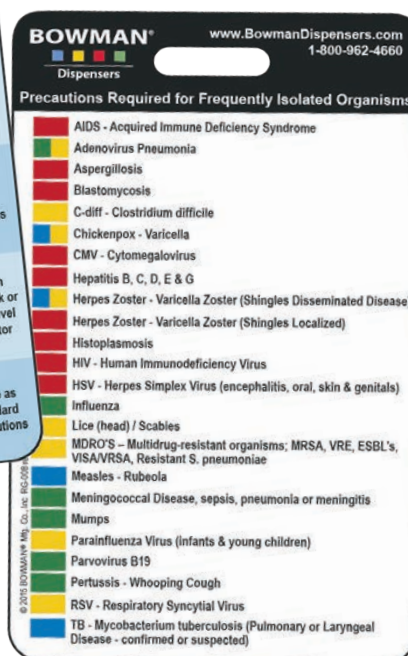

RG-006

Transmission Based Precautions Quick Reference Card - Horizontal
Made of PVC Plastic

RG-008

Transmission Based Precautions Quick Reference Card - Vertical
Made of PVC Plastic

▶ HOW TO USE A QUICK REFERENCE GUIDE

1

Attach card to name badge



RG-006

2

Identify organism - Match organism to isolation type

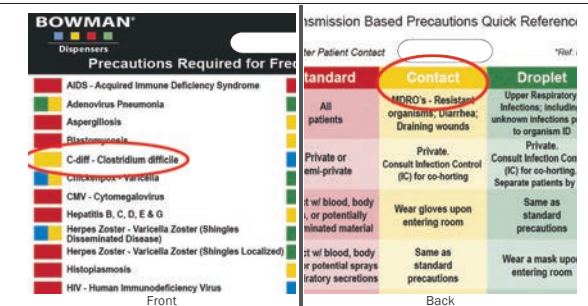

3

Print isolation sign
Free signage available at
www.BowmanDispensers.com



4

Place sign in sign holder



MP-047

5

Place sign holder on BOWMAN® Protection Systems



PS016-0512 with MP-047

This information is based on the Guideline for Isolation Precautions: Preventing Transmission of Infectious Agents in Healthcare Settings. Recommendations of the Healthcare Infection Control Practices Advisory Committee (HICPAC), CDC. <http://www.cdc.gov/hicpac/pdf/isolation/Isolation2007.pdf>

▶ PERMANENT MOUNTING OPTIONS

Dual Function

Standardization of PPE Location

Increase compliance by mounting the BOWMAN Protection System to the wall outside of each patient room so protective equipment is available to protect staff at all times.

Keyholes

Keyholes enable permanent mounting to a wall. (PS016-0233 shown)



Isolation Unit

By adding the clip-on sign holder, the unit becomes an isolation station when patients require isolation.

Permanent mounting to a wall with isolation sign (MP-047 and PS016-0233 shown)

Permanent Wall Hanger

Permanently mounted wall hanger located outside each patient room holds Protection Systems intermittently when patients require isolation.



Utilizing a Wall Hanger (MB-510 and PS016-0212 shown)



MB-510 CRS
Hanger - Wall

▶ PORTABLE MOUNTING OPTIONS



Traditional Door

Our most popular standard hanger, MB-600, holds BOWMAN Protection Systems on standard sized doors. The MB-601 is designed for extra tall doors.



MB-600 CRS
Hanger - Door



Door Hanger (MB-600 and PS016-0512 shown)

Fire Door

Hanger for metal bracketed fire doors. Holds Protection Systems at adjustable heights to accommodate door hardware on fire doors.



MB-450 CRS
Hanger - Metal Bracketed Doors



Fire Door Hanger (MB-450 and PS016-0512 shown)

Glass Door

Hanger for glass doors. Holds Protection System on glass utilizing double-sided, semi-permanent tape.



MB-500 CRS
Hanger - Glass

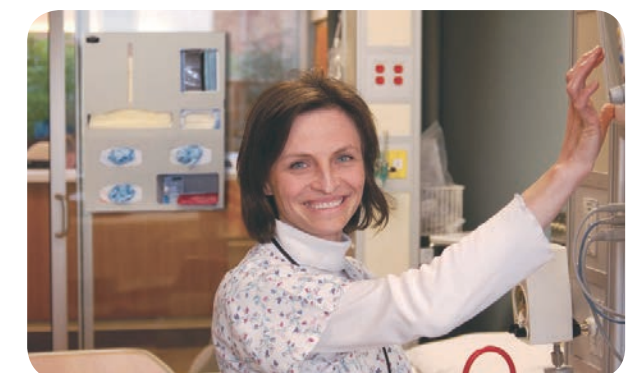

Glass Door Hanger (MB-500 and PS016-0512 shown)

Protection Systems	Permanent Mount or Portable	Launderable Gowns	Disposable Flat-Pack Gowns	Disposable Thumb Loop Gowns Out of Box	Disposable Thumb Loop Gowns in Box	Gowns, Single	Gowns, Double	Isolation Sign Holder
 <p>FM002-0213 White ABS Plastic 10.60"W x 23.50"H x 4.95"D</p>	✓				✓	✓		
 <p>LD-064 Quartz Beige ABS Plastic 16.75"W x 25.63"H x 4.00"D</p>	✓	✓	✓			✓		MP-047
 <p>PS015-0512 Quartz Beige Aluminum 25.05"W x 30.75"H x 4.65"D</p>	✓	✓	✓	✓	✓		✓	MP-047
 <p>MOST VERSATILE PS016-0512 Quartz Beige Aluminum 22.75"W x 25.63"H x 4.58"D</p>	✓	✓	✓	✓	✓	✓		MP-047
 <p>PS021-0512 Quartz Beige Aluminum 16.48"W x 25.18"H x 4.35"D</p>	✓		✓			✓		
 <p>PS022-0512 Quartz Beige Aluminum 22.75"W x 20.23"H x 4.58"D</p>	✓	✓	✓	✓	✓	✓		MP-047

Gloves, Double	Gloves, Triple	Gloves, Quad	Face Masks, Earloop - Single	Face Masks, Earloop - Double	Face Shield Masks	Storage Add-On	Storage Built-In	Signature Series Maple & Cherry ABS Plastic	Clear PETG	Quartz Beige ABS Plastic	Stainless Steel
✓			✓					Available with minimum order		Available with minimum order	
	✓		✓				✓	Available with minimum order		✓	
	✓			✓		MP-015 & MP-085	✓	Available with minimum order		PS015-0212	
	✓	✓	✓	✓	✓	MP-015 & MP-085	✓	PS016-0223 & PS016-0233	PS016-0111	PS016-0212	PS016-0300
	✓		✓			MP-015 & MP-085		Available with minimum order		LD-007	
✓			✓		✓	MP-015 & MP-085		Available with minimum order		LD-037	



FD-068 (ABS)
Infection Prevention System

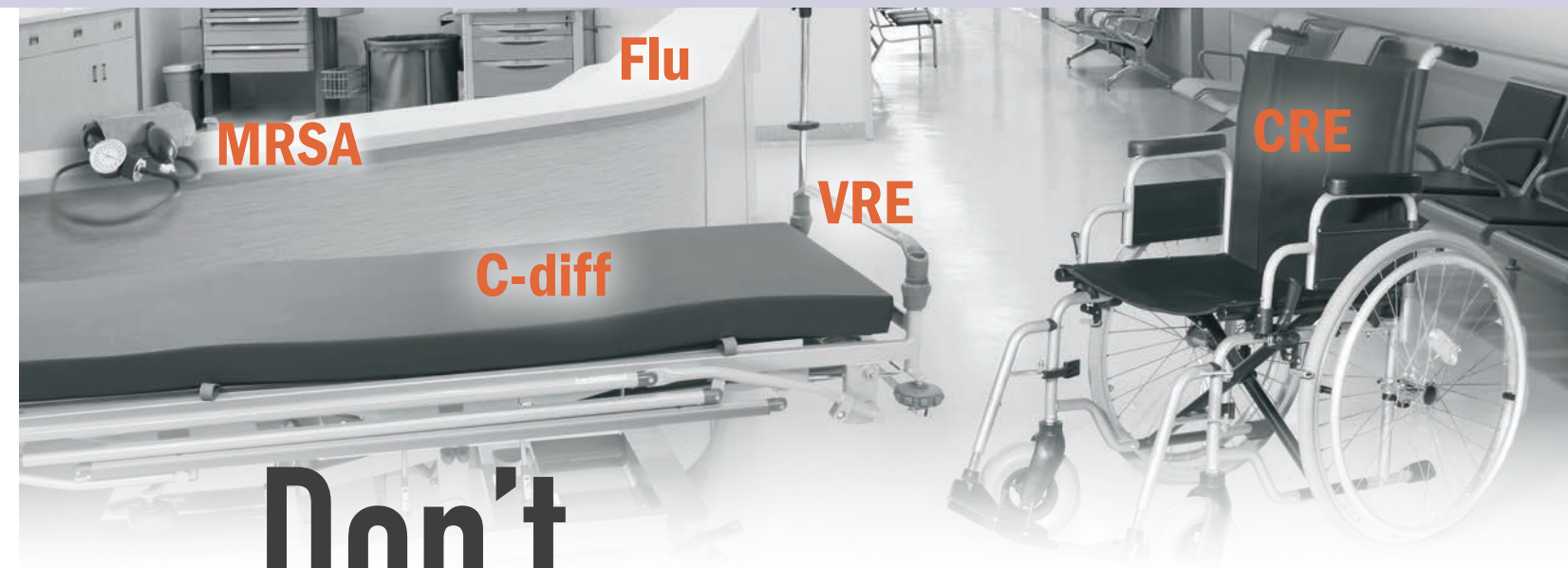

**Don't
TRANSPORT
your
INFECTIOUS
ORGANISMS!**



ED-097 (ABS) (PET)
Infection Prevention System
MP-075 Sign Holder included

EXAM ROOMS
Standardize location of supplies to ensure compliance with Infection Control policies—use FD-068 for separation of clean and dirty areas



Help decrease Healthcare-Associated Infections (HAI's) with the BOWMAN ED-097 Infection Prevention Station

Protect patients, visitors, and staff from microorganisms that spread from contact with contaminated surfaces and common use items, by placing the ED-097 station near:

- Transportation Services
- Nursing Stations
- Waiting Areas
- Office Environments



PUBLIC AREA PROTECTION

Comply with the CDC guidelines⁵ and take precautions to prevent the transmission of respiratory infections



MP-070 (PET)

Sign Holder - Vertical

Download free multilingual Cover Your Cough signage by visiting our website at www.BowmanDispensers.com



RS001-0512 (ALM)

Respiratory Hygiene Station

Optional sign holder (MP-070 shown, or MP-075) sold separately

Also available - (ABS) RS001-0212



- 1

Visual Alerts ○ Post visual alerts at the entrances of healthcare facilities, including emergency departments, physician offices, clinics, etc.
- 2

Cleaning Hands ○ Use of antiseptic hand wash if a sink for hand washing is not available.
- 3

Wearing Face Masks ○ Wear a mask if coughing. Masks available for visitor use.
- 4

Using Tissues ○ Cover the nose and mouth with a tissue when coughing or sneezing and properly dispose of tissues after use.



⁵This information is based on the CDC's Respiratory Hygiene/Cough Etiquette in Healthcare Settings guidelines. <http://www.cdc.gov/flu/professionals/infectioncontrol/resphgiene.htm>

Protecting Ports of Entry

TOP BENEFITS OF BOWMAN RESPIRATORY HYGIENE STATIONS & FLOOR STANDS



Place on a counter in a medical office or clinic

Versatility

Most units may be mounted to a floor stand, hung on a wall, or set on a counter.

Cost Effectiveness

Infectious outbreak investigations and staff absenteeism are very costly. BOWMAN Respiratory Hygiene Stations provide the items needed to support efforts in preventing the transmission of infections.

Convenience

Placed where infection prevention supplies are needed most—at ports of entry.

Durability

BOWMAN Respiratory Hygiene Stations are made of aluminum or ABS plastic.

Accessibility

Standardizing the location of infection prevention and supplies.



Place in a lobby or waiting room—mounted on a floor stand

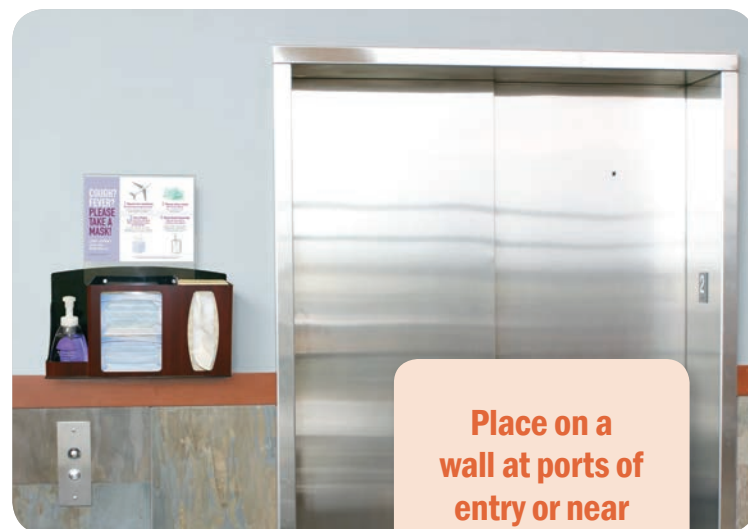

Place on a wall at ports of entry or near an elevator



New Material



MP-070 (PET)

Sign Holder - Vertical

Sold separately from Respiratory Hygiene Station

Also available - MP-075

RS001-0512 (ALM)

Accommodates either one bottle of hand sanitizing gel or one container of hand sanitizing wipes

KS010-0412 (CRS)

Floor Stand

Color Options

KS010-0420

Black

Cold Rolled Steel

KS010-0434

Matte White

Cold Rolled Steel

RS001-0512 (ALM)

Respiratory Hygiene Station

Color Options

RS001-0212

Quartz Beige

ABS Plastic

RS001-0223

Maple

Fauxwood Plastic

RS001-0233

Cherry

Fauxwood Plastic

NEW Cover Your Cough Compliance Kits

Stations, Stands & Sign Holders are now available as one package

See page 32 for details

Easy Ordering, Easy Savings, EASY CHOICE

BOWMAN now offers Cover Your Cough Compliance Kits of your favorite Respiratory Hygiene Station as ONE part number. Save up to 45% on shipping costs and gain the convenience that comes with managing just one part number and one package.

CYC COMPLIANCE KIT Station, Stand & Sign: (ALM) (CRS) (PET)

- BD101-0012:** RS001-0512, KS010-0412, MP-070
- BD102-0012:** RS001-0512, KS010-0412, MP-075
- BD105-0012:** RS005-0512, KS010-0412, MP-070
- BD106-0012:** RS005-0512, KS010-0412, MP-075

CYC COMPLIANCE KIT Station, Stand & Sign: (ABS) (CRS) (PET)

- BD111-0012:** RS001-0212, KS010-0412, MP-070
- BD112-0012:** RS001-0212, KS010-0412, MP-075

Station & Sign:

- BD201-0012:** RS001-0512, MP-070
- BD202-0012:** RS001-0512, MP-075
- BD205-0012:** RS005-0512, MP-070
- BD206-0012:** RS005-0512, MP-075

Station & Sign:

- BD211-0012:** RS001-0212, MP-070
- BD212-0012:** RS001-0212, MP-075

Protecting Ports of Entry

Hand Sanitizer Pump or Foam Dispenser



RS005-0512 (ALM)

Respiratory Hygiene Station Locking

Also available - FD-112 (ABS)

Please confirm hand sanitizer dispenser dimensions before ordering

- New wider back plate to accommodate larger brand hand sanitizer pump or foam dispensers
- Keyholes for wall mounting, or can mount to a floor stand
- Optional sign holder (MP-070 shown, or MP-075) sold separately
- Non-locking unit (RS004-0512 or FD-111) also available
- CYC Compliance Kit - all in one purchasing option (BD205-0012) also available



PERFECT FOR SCENARIOS WHERE YOU HAVE HAND GEL DISPENSERS ALREADY IN PLACE

Mask & Facial Tissue



RS002-0512 (ALM)

Respiratory Hygiene Station Locking

Also available - RS002-0212 (ABS)

- Holds two boxes of face masks, and one or two boxes of facial tissues
- Place on counter or other flat surface, mount to a floor stand or mount on a wall
- Keyholes for wall mounting
- Optional sign holder (MP-075 shown, or MP-070) sold separately

BW100-0212 Cross Reference Guide

Manufacturer	Product #
3M	9222, 9252, 9321A, 9338
Cardinal Health	CA43-12
Crosstex	JWGP
Dial	06040, 00213
Kleenex	34618
Purell	5791, 5798
Steris	1181-RP, 1199-FH, 1452-RF, 1460-RP

Hand Gel Bottle Holder

BW100-0212 (ABS)

Bottle Holder Universal - Hand Gel



DISINFECT & PROTECT, ANYTIME & ANYWHERE

with the KS101-0029 Hand Hygiene Station, from BOWMAN



KS102-0029* CRS
 Hand Sanitizer Floor Stand Plus
 Includes drip tray accessory (attaches to floor stand)



KS123-0529
 Infection Prevention Station Accessory
 Optional tissue and face mask dispenser mounts to back of backplate
 Accommodates most major manufacturers' tissues and earloop face masks
 Also available for wall mounting option - KS122-0529

KS101-0029* CRS
 Hand Sanitizer Floor Stand
 Shown with hand sanitizer dispenser (not included)
 Accommodates most major manufacturers' hand sanitizer, hand lotion, and foam dispensers



HAND HYGIENE IS THE #1 WAY to prevent the spread of infection

THE TOP 10 REASONS You'll Love BOWMAN Glove Box Dispensers

1. **Universal Fit** - Dispensers fit most standard glove boxes
2. **Cost Effective** - Good, better and best material options to meet any budget
3. **A Finish for Every Interior** - Available in stainless steel, powder-coated steel, PETG plastic, ABS plastic, fauxwood ABS plastic, polycarbonate plastic, and coated-wire
4. **Most Size Configurations Available** - Single, double, triple, and quad
5. **Place Them Anywhere** - Most glove box dispensers can be mounted vertically and horizontally
6. **Drop-In Convenience** - Available in Divided and Non-Divided options
7. **Display Your Way** - Minimal to full glove box visibility
8. **Private Labeling** - Available for most units
9. **Store or Organize Anything** - Think outside the box
(See pages 74-75 for more ideas)
10. **Made in the USA**



GL100-0212 (ABS)
Glove Box Dispenser
Single
Also available - GL100-1214 (PLC)



GL300-1214 (PLC)
Glove Box Dispenser
Triple with Dividers
Also available - GL300-0212 (ABS)



RESTOCKING IS A BREEZE!

With BOWMAN divided dispensers, glove boxes stay in place for quick and easy replacement of used boxes.

Material	Single	Double	Triple	Quad
ABS Plastic - Cherry				
	GL010-0233	GL020-0233	GL030-0233	GL040-0233

Material	Single	Double	Triple	Quad
ABS Plastic - Maple				
	GL010-0223	GL020-0223	GL030-0223	GL040-0223

Material	Single	Double	Triple	Quad
ABS Plastic - Quartz Beige				
	GL100-0212	GL020-0212	GL300-0212	GL040-0212

Material	Single	Double	Triple	Quad
Clear PETG & Polycarbonate Plastic				
	GL100-1214	GL020-0111 (PET)	GL300-1214	GL040-0111 (PET)

Material	Single	Double	Triple	Quad
Powder-Coated Steel - White				
	GB-001	GL002-0413	GL003-0413	GL004-0413

Material	Single	Double	Triple	Quad
Stainless Steel				
	GS-004	GS-122	GS-123	GS-124

Material	Single	Double	Triple	Quad
Clear PETG Plastic	 GP-013	 GP-014	 GP-015	 GP-061
Coated-Wire - White	 GL011-0613*	 GL022-0613*	 GL033-0613*	 GL044-0613*
Powder-Coated Steel - White	 GB-001	 GB-002	 GB-003	 GB-059
Stainless Steel	 GS-004	 GS-005	 GS-006	 GS-060

ASK FOR THE STRONG CHOICE.

High quality BOWMAN Glove Box Dispensers are manufactured with Steel, Polycarbonate, PETG and ABS plastics.

- ✓ Manufactured with quality plastics
- ✓ Durable and long lasting
- ✓ Non-divided and divided for easy loading and unloading
- ✓ Tolerates hospital grade cleaning agents
- ✓ Mounts vertically or horizontally (*most units*)
- ✓ Cost effective
- ✓ Wide variety of material and color options
- ✓ Made in the USA

GL300-1214 PLC

Glove Box Dispenser Triple with Dividers



OTHERS USE ACRYLIC - THE WEAK CHOICE

- ✗ Discolors with alcohol and hospital cleaners
- ✗ Brittle and breaks easily
- ✗ Hidden costs: Replacement
- ✗ Manufactured overseas

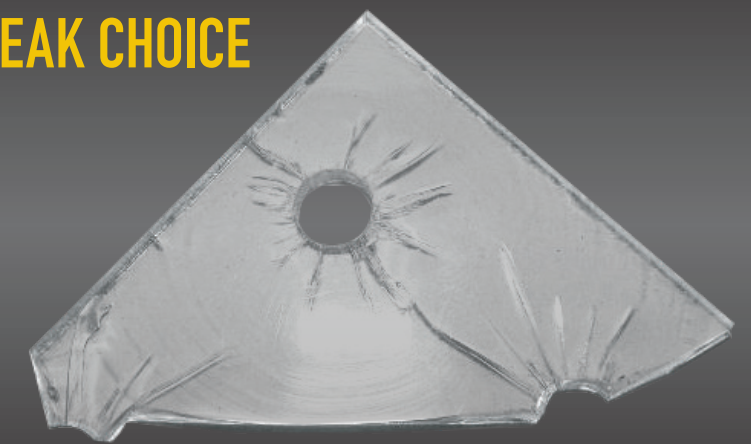

▶ FOOD SERVICE - NARROW



STS
GL102-0300
Stainless Steel



PET
GL102-0111
Clear PETG Plastic

Fits boxes no larger than 4.88"W x 10.00"H x 2.75"D
(12.4 cm x 22.9 cm x 7.0 cm)

▶ NARROW

Fits most brand name narrow glove boxes **PET**



GP-071
Fits boxes no larger than 5.50"W x 9.75"H x 2.75"D
(14.0 cm x 24.8 cm x 7.0 cm)



GP-072
Fits boxes no larger than 5.25"W x 10.00"H x 2.75"D
(13.3 cm x 25.4 cm x 7.0 cm)



GP-073
Fits boxes no larger than 5.25"W x 10.00"H x 2.75"D
(13.3 cm x 25.4 cm x 7.0 cm)

▶ TOP LOADING

Features

- Keyholes for vertical wall mounting
- Solid back
- Made of clear PETG plastic **PET**



GP-310



GP-320



GP-330



GP-340

▶ SPACE SAVER

Vertical Clear PETG Plastic **PET**

Vertical Powder-Coated Steel **CRS**

Vertical Stainless Steel **STS**



GP-106



GP-107



GB-067



GB-068



GS-108



GS-109

Top Loading and Space Saver Glove Box Dispensers are loaded from the top only and therefore require that all glove boxes be removed to replace the bottom box.

► CUSTOM & INTERIOR CABINET

Did you know?

- BOWMAN offers custom designed products; please contact us for more information.
- Interior cabinet mounting is available with select BOWMAN dispensers or custom designed products.



GL300-1214 (PLC)
Glove Box Dispenser
Triple with Dividers



View B: Shown from outside the cabinet

View A: Shown attached to the inside of a cabinet with pre-cut glove dispenser holes



GB-144 (CRS)
Glove Box Dispenser – Single



View C: Shown in a Dental Office Cabinet⁶

⁶Photo provided by Cabinet Plus, Inc.



Keyholes

Three-way keyholes for vertical or horizontal wall mounting on most Glove Box Dispensers



**RIGHT
LOAD**

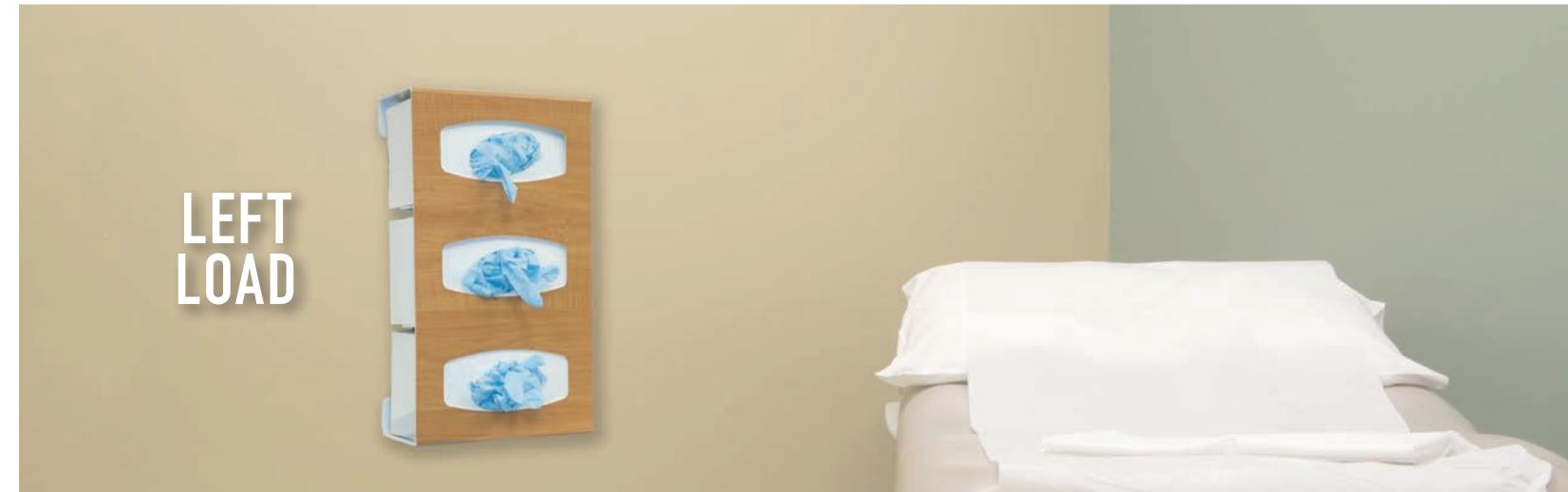

**LEFT
LOAD**

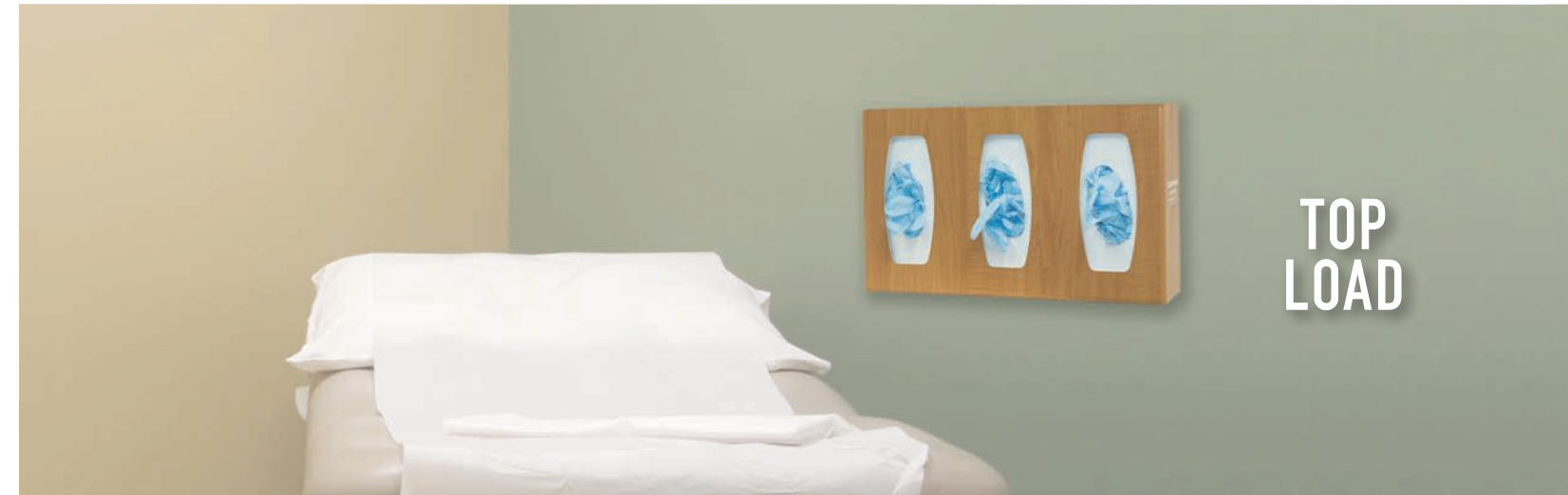

**TOP
LOAD**



Earloops

Exact fit dispenser for most standard size earloop face mask boxes



FB-037 (CRS)

Face Shields

Exact fit dispenser for most standard size face shield boxes



FB-090 (CRS)



Ties (CRS)

Exact fit dispenser for most standard tie face mask boxes



FB-021

Bulks (PET)

Holds face masks in bulk quantities



FD-005

One Box Capacity Cone Masks

FP-017

Universal (ABS)

Holds a variety of boxed face masks



FM100-0212

Earloop

FM200-0212

Face Shield

FM300-0212

Cone

Combo

Holds multiple styles of face masks in one convenient location



FM004-0213 (ABS) (PET)

Surgical Face Mask Dispenser with Signs
Three MP-035 Sign Holders included



FM002-0213 (ABS)

Face Mask Dispenser - Combo

**BOWMAN
MAKES
IT EASY!**

Use our convenient cross reference tool to determine which BOWMAN Face Mask Dispenser fits your style and brand of face masks.

Cross reference tools can be found on pages 48-53

**UNIVERSAL SATISFACTION:
CHANGE YOUR SUPPLIER**

KEEP YOUR DISPENSERS







FACE MASK SOLUTIONS FOR EVERY INDUSTRY



Part Number	Image	Units	W (L)	H	D	Weight	
FM100-0212 (Earloop Style)		IN	8.25	4.63	5.75	LB	0.5
		CM	21.0	11.8	14.6	KG	0.2
FM200-0212 (Shield Style)		IN	9.75	8.63	4.75	LB	1.0
		CM	24.8	21.9	12.1	KG	0.5
FM300-0212 (Cone Style)		IN	6.75	7.13	5.75	LB	0.7
		CM	17.1	18.1	14.6	KG	0.3

3M	Cardinal Health	Gerson	Halyard Health Kimberly-Clark	McKesson	MediChoice PrimaGard PriMed	Medline	Moldex	Precept	Prestige Ameritech	Sperian	TIDI
1816 1835 1840	AT70021 AT7004 AT71021 AT74531 AT7511 AT771141 AT771211		25868 28802 28806 28808 37525 47107 47117 47127 48100 48296 49310 59928	91-1000 91-1200 91-1400 91-2002	PG41001, PG41073 PG41092, PG41200 PG41201, PG41241 PG41331, PG42000 PG42001, PG42092 PG42121, PG42241 PG42320, PG42331 PG42332, PG42421 PG44051, PG44241 PG44331, PG46001 PG4ELM001	NON27110 NON27120 NON27122 NON27374 NON27376 NON27377 NON27385 NON27412EL NON27712EL		15100 15101 15130 15155 15160 15200 15211 15212 15240 15260 15300 15320 15420 15500 65-3320 65-3322	FM81000 FM81110 FM85011		9010 9020 9030 9040
1818 1870	AT51035 AT52005 AT54535 AT54635 AT71039 AT71235 AT72835 AT73035 AT74535 AT74631 AT74635 AT7505-P AT7511-WE AT771145		28800 28804 28809 28821 47147 47500 48247 62114	91-1600 91-2600	PG41573 PG41592 PG42073 PG42560 PG42562 PG43092 PG44073 PG44241 PG45033 PG45073 PG46003 PG46403	NON27410 NON27410EL NON27600		15310 15330	FM82120 FM84210 RP88020	14110452	
1800+NL 1860 8210 8511 1860S	N95-ML	2130C 1730 2735				NON24506 NON24506A NON24507	1200N95 1512N95 1712N95 2200N95 2300N95 2730N100	65-3333 65-3395 65-3395S	RP88020	14110388 N1105	

WHITE POWDER-COATED STEEL

Part Number	Image	Units	W (L)	H	D	Weight	
						LB	KG
FB-021		IN	7.44	4.75	4.81	LB	0.9
		CM	18.9	12.1	12.2	KG	0.4
FB-037		IN	7.56	4.25	4.13	LB	0.7
		CM	19.2	10.8	10.5	KG	0.3
FB-040		IN	8.00	6.00	5.25	LB	1.3
		CM	20.3	15.2	13.3	KG	0.6
FB-063		IN	7.80	7.50	5.25	LB	1.4
		CM	19.8	19.1	13.3	KG	0.6
FB-064		IN	7.56	4.25	4.13	LB	0.8
		CM	19.2	10.8	10.5	KG	0.3
FB-090		IN	9.06	7.53	4.06	LB	1.2
		CM	23.0	19.1	10.3	KG	0.5
FB-091		IN	7.90	7.70	5.00	LB	1.2
		CM	20.1	19.6	12.7	KG	0.5

Part Number	3M	Cardinal Health	Halyard Health Kimberly-Clark	McKesson	MediChoice PrimaGard PriMed	Medline	Precept	Prestige Ameritech	Sperian	TIDI
FB-021	1835	AT74531	28802, 28806 28808, 37525 47107, 47117 47127, 48100 48105, 48296 49214, 49310 59928, 62113		PG41092 PG41241		15200 15211 15212 15240 15260 15320 15420 65-3320 65-3322			
FB-037	1816 1840	AT70021 AT7004 AT71021 AT74531 AT7511 AT771141 AT771211	28802, 28806 28808, 37525 47080, 47095 47107, 47117 47127, 48201 48296, 49214 62113	91-2002	0205ELM001 PG41001 PG41092 PG41200 PG41201 PG41241 PG41331	NON27375 NON27378 NON27712EL		FM81000 FM85011		9010 9020 9030 9040
FB-040		AT51035 AT54535 AT71235 AT72835 AT74535 AT752005 AT771145	48220 49125 49235	91-1000 91-1200 91-1400	PG42331 PG42332 PG42333 PG42421	NON27110 NON27361A NON27376 NON27377 NON27408 NON27412 NON27412EL		FM81110		
FB-063	8514	AT51035 AT54535 AT71235 AT72835 AT752005 AT771145			PG42073 PG42333 PG44073	NON27361A NON27382 NON27408 NON27410 NON27410EL NON27412		FM81110		
FB-064	1840	AT70021 AT7004 AT71021 AT74531 AT7511 AT771141 AT771211	25867, 25868 25869, 28802 28806, 28808 28810, 37525 47080, 47095 47107, 47117 47127, 48100 48105, 48201 48296, 49214 49310, 62113	91-2002	0205ELM001 PG41001 PG41010 PG41092 PG41200 PG41201 PG41241 PG41331	NON27122 NON27375 NON27378 NON27712EL		FM81000 FM85011		9010 9020 9030 9040
FB-090	1818	AT71039 AT74631 AT74635 AT7511-WE	28800 28804 28809 28821 47147 47500 48247 62114	91-1600 91-2600	PG41573 PG41592 PG42592 PG45033 PG45073	NON27600	15310 15330	FM82120 FM84210	14110452	
FB-091		AT51035 AT54535 AT71235 AT72835 AT73035 AT74535 AT7505-P AT752005 AT771145	48220 49215 49235			NON27361A NON27382 NON27408 NON27410 NON27410EL NON27412		FM81110		

CLEAR PETG PLASTIC

Part Number	Image	Units	W (L)	H	D	Weight	
FP-021		IN	7.95	4.23	5.20	LB	0.5
		CM	20.2	10.7	13.2	KG	0.2
FP-022		IN	8.12	7.72	4.91	LB	0.9
		CM	20.6	19.6	12.5	KG	0.4
FP-038		IN	7.70	4.32	4.27	LB	0.4
		CM	19.6	11.0	10.8	KG	0.2
FP-120		IN	9.20	7.50	4.20	LB	0.7
		CM	23.4	19.1	10.7	KG	0.3
FP-121		IN	7.70	4.35	4.13	LB	0.5
		CM	19.6	11.0	10.5	KG	0.2
FP-122		IN	8.08	7.60	5.58	LB	0.8
		CM	20.5	19.3	14.2	KG	0.3

Part Number	3M	Cardinal Health	Halyard Health Kimberly-Clark	McKesson	MediChoice PrimaGard PriMed	Medline	Precept	Prestige Ameritech	Sperian	TIDI
FP-021	1835	AT74531	28802, 28806 28808, 37525 47107, 47117 47127, 48100 48105, 48296 49214, 49310 62113	91-1000 91-1200 91-1400	PG41073, PG41092 PG41241, PG42000 PG42001, PG42092 PG42121, PG42320 PG42331, PG42332 PG42421, PG44021 PG44051, PG44241 PG44331, PG46001	NON27110 NON27120 NON27374 NON27376 NON27377 NON27385 NON27412EL	15100, 15101 15130, 15150 15155, 15160 15200, 15211 15212, 15240 15260, 15300 15320, 15420 15500, 65-3320 65-3322			9030 9040
FP-022		AT51035 AT54535 AT71035 AT71235 AT72835 AT752005 AT771145			PG42073 PG42121 PG42332 PG42333 PG43092 PG44073	NON27361A NON27382 NON27408 NON27410 NON27412 NON27140EL NON27412		FM81110		
FP-038	1816 1840	AT70021 AT7004 AT71021 AT74531 AT7511 AT771141 AT771211	28802, 28806 28808, 37525 47107, 47117 47127, 48100 48105, 48296 49214, 49310 62113	91-2002	0205ELM001 1773ELM001 PG41001 PG41092 PG41200 PG41201 PG41241 PG41331	NON27122 NON27375 NON27378 NON27712EL		FM81000 FM85011		9010 9020 9030 9040
FP-120	1818	AT71039 AT74631 AT74635 AT7511-WE	28800 28804 28809 28821 47147 47500 48247 62114	91-2600 91-1600	PG41573 PG41592 PG42592 PG45033 PG45073	NON27600	15310 15330	FM82120 FM84210	14110452	
FP-121	1840	AT70021 AT7004 AT71021 AT74531 AT7511 AT771141 AT771211	25867, 25868 25869, 28802 28806, 28808 28810, 37525 47080, 47095 47107, 47117 47127, 48100 48105, 48201 48296, 49214 49310, 59928, 62113	91-2002	0205ELM001 1773ELM001 PG41001 PG41010 PG41092 PG41200 PG41201 PG41241 PG41331	NON27122 NON27375 NON27378 NON27712EL		FM81000 FM85011		9010 9020 9030 9040
FP-122	8514	AT51035 AT54535 AT71235 AT72835 AT752005 AT771145	48220 49215 49235		PG43573	NON27361A NON27382 NON27408 NON27410 NON27410EL NON27412		FM81110		

Stainless Steel



Bulk Dispensers from BOWMAN give you endless organizing options. What will you store in yours?

Hair Nets
Gloves
SURGEONS CAPS
Scrub Brushes
SHOE COVERS
BOUFFANT CAPS
Boot Covers
BEARD COVERS
EARPLUGS Sponges



BK001-0300 (STS)
Tall Single Bin



BK002-0300 (STS)
Short Single Bin



Clear PETG Plastic

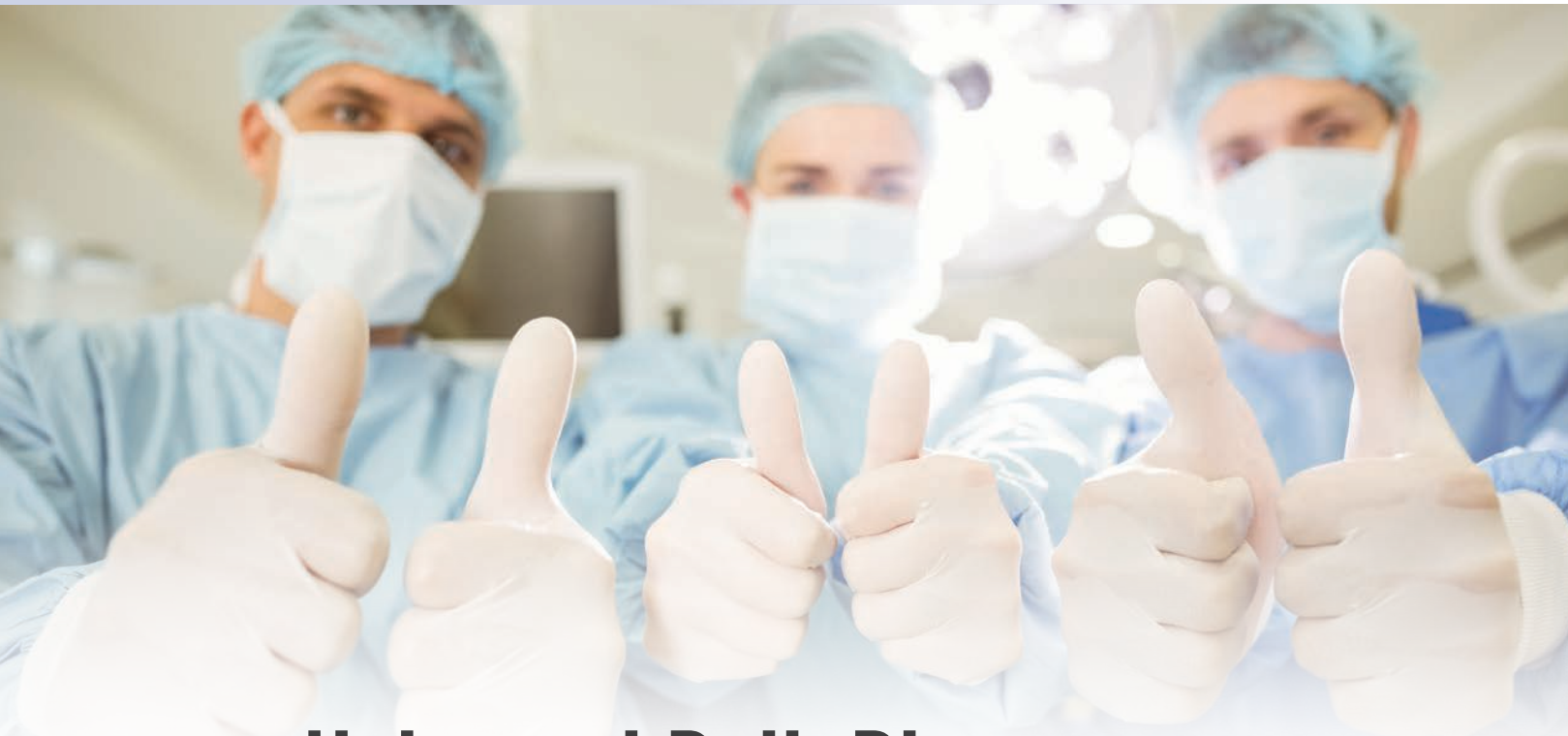

Universal Bulk Dispensers

From caps to booties, Universal Bulk Dispensers offer convenient storage and accessibility—for any market

▶ SINGLE BINS



BP-021 (PET)
Short



BP-011 (PET)
Tall

▶ DOUBLE BINS



BP-022 (PET)
Short



BP-012 (PET)
Tall

▶ TRIPLE BINS



BP-023 (PET)
Short



BP-090 (PET)
Tall

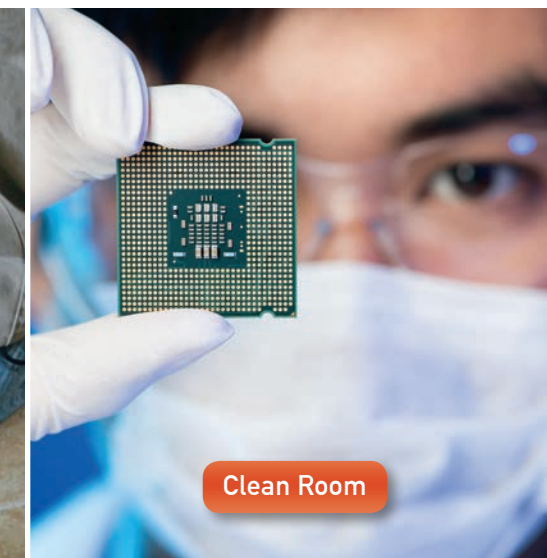



GN001-0212 (ABS)

Holds a variety of gowns in bulk
 Hinged lid for easy opening
 Keyholes for wall mounting or door hanger cut out

The GN001-0212 offers
EASY INSTALLATION
 and gown storage
VERSATILITY

Store these and more:

- 1. 2 Boxes of Thumb Loop Gowns
- 2. 2 Stacks of Thumb Loop Gowns
- 3. 2 Packs of Overhead Cover Gowns
- 4. Laundered Gowns
- 5. Flat Pack Gowns
- 6. Aprons
- 7. Jumpsuits

GN100-0212 Cross Reference Guide

Manufacturer	Product Number
Cardinal Health	AT4441
Cardinal Health	42110PG
Cardinal Health	5210PG
Cardinal Health	5213PG
Graham Medical	57560
Halyard Health Kimberly-Clark	69316
Halyard Health Kimberly-Clark	69490
Halyard Health Kimberly-Clark	69603
Medline	CRI5000
Medline	CRI5001
Medline	NON27SMS5F
Medline	NON27SMS5FXL
Medline	NONLV200F
Medline	NONLV200FXL
Medline	NONLV200TL
Medline	NONLV200TLXL
Medline	NONTH150
Medline	NONTH180
Medline	NONTH200
Medline	NONTH350
Medline	NONTH400
MediChoice	0205077755
MediChoice	430477735XL
TIDI	8575
TIDI	8576
TIDI	8578

**The TOP 3
 BENEFITS**
 of the BOWMAN
**GN100-0212 Universal
 Gown Dispenser**

1. Universally sized to hold a variety of box sizes of thumb loop style gowns
2. No need to replace dispensers when gown supplier contracts change
3. Cross reference includes over 25 different products from 6 major gown manufacturers



GN100-0212 (ABS)



BEFORE

AFTER



SD-010 (ABS) (PET)
Surgical Apparel Organizer

Products shown in
image at top right:
BP-022, BP-090, SD-010

**CREATE
ORDER**
with **BOWMAN**
Specialty
Dispensers

Surgical Protection Systems

PS017-0212
(ABS) (PET)
Protection System
Surgical



FEATURING A REMOVABLE SHELF
WHICH CREATES 2 STORAGE AREAS
WHEN INSTALLED

Surgical Dispensers

Scrub Sink Area Dispensers



PS023-0512 (ALM)
 Protection System
 Also available - LP-004 (ABS) (PET)



FP-017 (PET)
 Face Mask Dispenser - Bulk
 Fits Pre-Assembled Eye Shields:
 Cardinal Health #CAHEYEWEAR
 MediChoice #PEW050
 Medline #NONASMBLD



PD003-0111 (PET)
 Protection Dispenser
 TIDI Custom
 TIDI Tower™ Dispenser with
 TIDIShield® Grab 'n Go™
 Fits Pre-Assembled Eye Shields:
 #9210A-100

▶ CUSTOM FIT BOUFFANT CAP & SHOE COVER DISPENSERS



BB-034 (CRS)
 Bouffant Cap or Shoe Cover
 Dispenser



BP-007 (PET)
 Bouffant Cap or Shoe Cover
 Dispenser



SP-003 (PET)
 Shoe Cover Dispenser

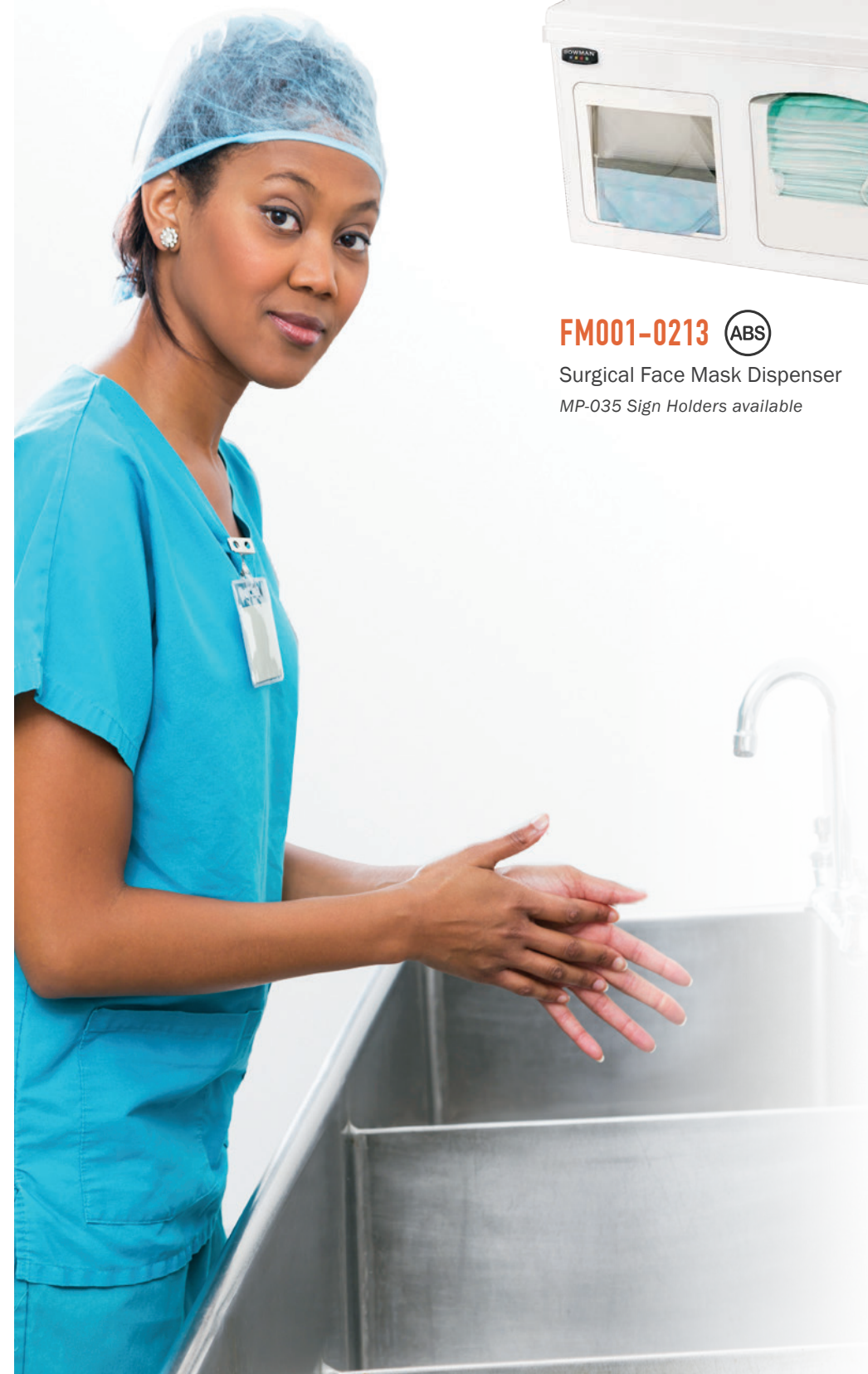

FM001-0213 (ABS)
 Surgical Face Mask Dispenser
 MP-035 Sign Holders available



CL006-0213 (ABS)
 Scrub Brush Dispenser



THE TOP 5 BENEFITS OF BOWMAN UNIVERSAL DISPENSERS

1. Holds most major manufacturers' sterile procedure area PPE products such as bouffant caps and shoe covers, plus industrial wipes and masks
2. By incorporating our spring design, our universally sized dispensers securely hold a variety of box sizes
3. 3 different designs to accommodate different geometric shaped boxes
4. 3 styles hold over 95 different boxes from major manufacturers, including: Cardinal Health, Halyard Health/Kimberly-Clark, MediChoice, Medline and more
5. For a complete list of compatible products, please see the cross reference on pages 66-67



PD200-0212 (ABS)

Protection Dispenser - Universal Boxed - Shoe Cover/Wipes/Cap/Other - Large

Universal Size
for **ANY**
Industry



PD100-0212 (ABS)

Protection Dispenser
Universal Boxed
Shoe Cover/Wipes/Cap/Other



PD300-0212 (ABS)

Protection Dispenser - Universal Boxed - Shoe Cover/Wipes/Cap/Other
Suited to dispense many products either vertically or horizontally

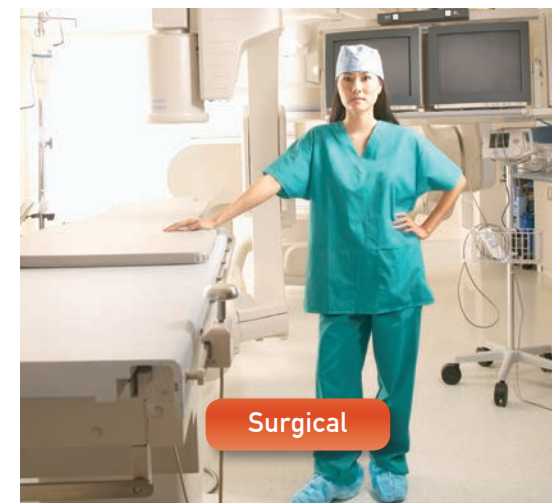

Surgical

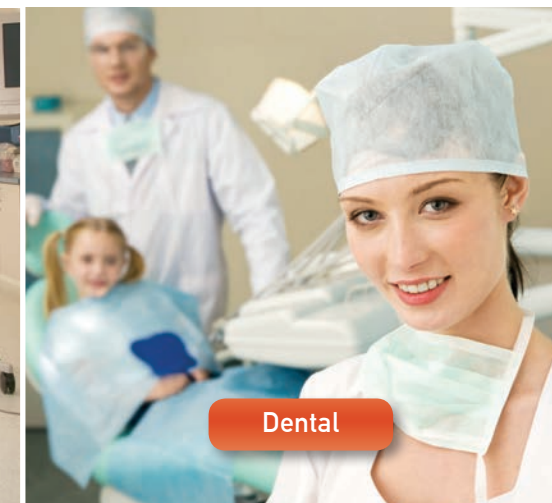

Dental



Food Service

Part Number	Image	Units	W (L)	H	D	Weight	
PD100-0212		IN	12.25	10.13	7.63	LB	1.1
		CM	31.1	25.7	19.4	KG	0.5
PD200-0212		IN	12.50	10.13	9.88	LB	1.1
		CM	31.8	25.7	25.1	KG	0.5
PD300-0212		IN	13.70	5.73	6.95	LB	1.0
		CM	34.8	14.6	17.7	KG	0.5

Boot/Shoe Covers	Caps & Hoods	Face Masks/Shields	Gloves	Shop Towels
<p>Cardinal Health: 2850, 2852, 2854, 4850, 4852, 4854, 4855, 4859SS, 5850, 5852, 5854, 5859</p> <p>Halyard Health / Kimberly-Clark: 69114, 69121, 69252, 69254, 69353, 69551, 69571, 69572, 69671, 69672</p> <p>MediChoice: 77724, 77725, 77727, 77728, 77729</p> <p>Medline: CRI2000, CRI2001, CRI2002, CRI2003, NON28758, NON28759, NON28852, NON29858, NON29859</p>	<p>Cardinal Health: 3224R, 3244, 3274, 3474, 3476, B24HD</p> <p>Halyard Health / Kimberly-Clark: 69083, 69086, 69088, 69089, 69110, 69196, 69221, 69240, 69520, 69801, 69803, 69807, 69808, 69809</p> <p>MediChoice: 77701, 77702, 77706</p> <p>Medline: CRI1000, CRI1001, CRI1002, CRI1003, CRI1004, CRI1005, CRI1008, CRI1009, CRI1203, NON28226, NON28228, NON28229, NON28230R, NON28233F, NON28234P, NON28233B, NON28533B, NON28625, NON28626, NON30223B, NON30232B, NON30233B, NONSH100C</p>	<p>3M: 1805, 1818FSG, 1838FSG, 1838R, 1870, 9105</p>	<p>Covidien: CTS731L</p>	<p>Halyard Health / Kimberly-Clark: 34790</p>
<p>Cardinal Health: 8453, 8454</p> <p>Medline: NON27143, NON27144XL, NON27145, NON27150</p>				<p>Halyard Health / Kimberly-Clark: 75190, 75260</p>
	<p>Cardinal Health: 4359</p> <p>Medline: NON28626, NON28625</p>	<p>Medline: NONFS300</p>	<p>Medicochoice: 1773MC147214</p>	

Biohazard Bag Holders



**Convenient
& Easy
to Use**

- ✓ Holds a one, three, or five gallon biohazard bag
- ✓ Screw holes for wall mounting
- ✓ Made of white coated-wire
- ✓ Easy-open ABS plastic hinged lid



MW-001* (ABS) (WIR)
Biohazard Bag Holder
1 Gallon



MW-003* (ABS) (WIR)
Biohazard Bag Holder
3 Gallon



MW-005* (ABS) (WIR)
Biohazard Bag Holder
5 Gallon

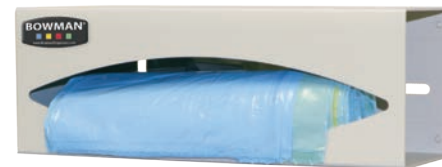

BG001-0512 (ALM)
Bag Dispenser - Single
Holds one roll of bags up to 9.50" long and 3.40" diameter
Also available - BG001-0212 (ABS)



BG002-0512 (ALM)
Bag Dispenser - Double
Holds two rolls of bags up to 9.50" long and 3.40" diameter
Also available - BG002-0212 (ABS)



PS004-0111 (PET)
Protection System
Glove and Bag
Holds one roll of bags up to 9.50" long and 3.40" diameter
Also available - PS004-0212 (ABS)



BG008-0111 (PET)
Bulk Dispenser
Flat Pack Bio Bag



New
BG009-0512 (ALM)
Bag Dispenser - Single
Large Capacity
Holds one roll of bags up to 12.00" long and 6.00" diameter
Two way keyholes for vertical or horizontal wall mounting
If bag roll weighs more than 4.5lbs., dispenser must be mounted vertically

Bedpan & Urinal Dispenser

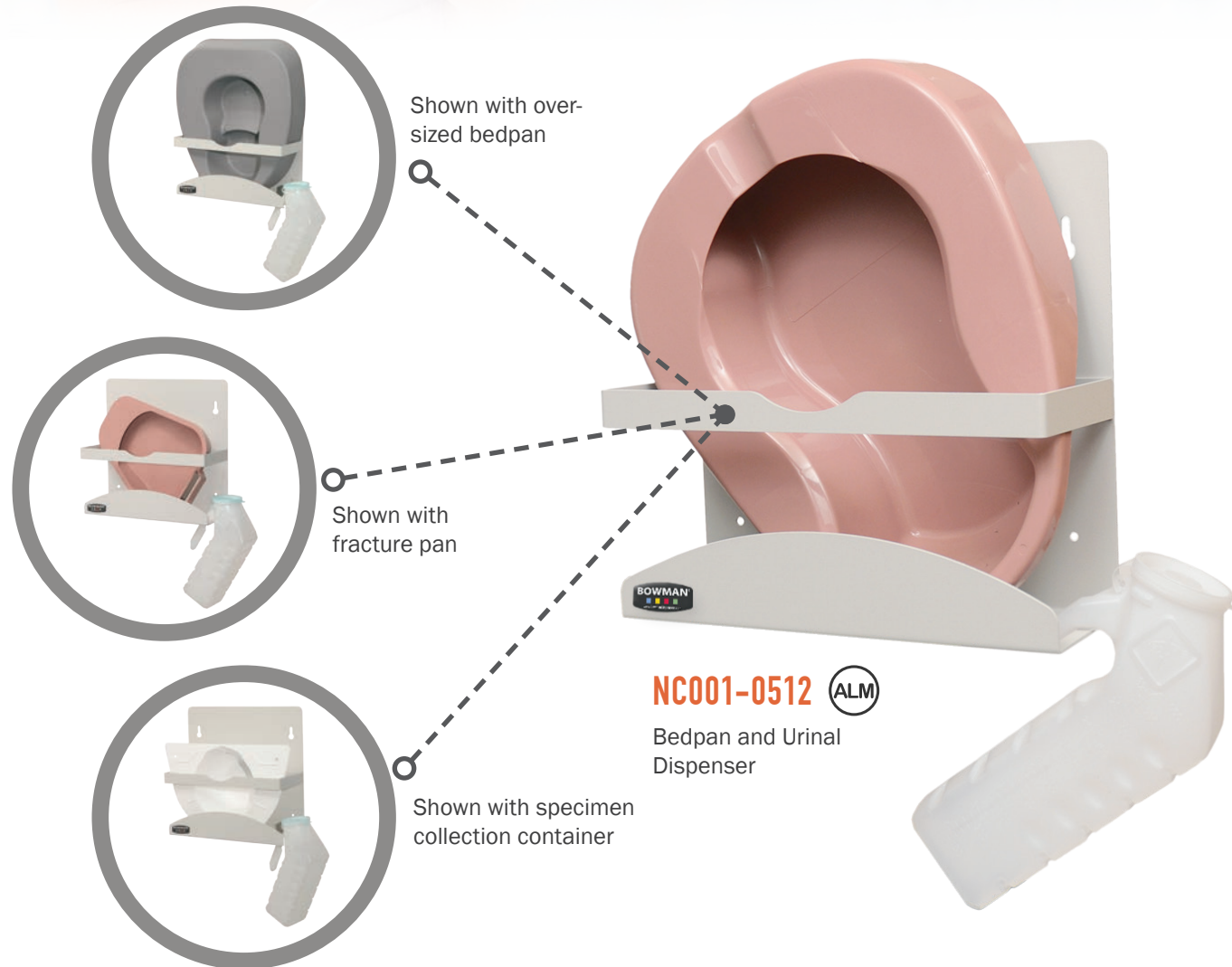

Disposable Wipe Dispenser



- BWX01-0412 (CRS)**
 Disposable Wipe Bracket
- Expandable from 3.12" to 5.50"
 - Front Loading
 - Mounts to a wall for stationary placement

BWX01-0412 Cross Reference Guide

Manufacturer	Product #
Clorox	01594, S-15766
Halyard Health Kimberly -Clark	30760, 58028, 58040
Metrex	13-5150
PDI	NPKQ89072, P13472, P13872, P15984, P54072, P63884, Q55172, Q73484, Q77272, Q86984, Q89072, Q94384
SafeTec	34405, 34410
Spartan	1086
Steris	1608-GS
Tough Guy	4AZR9
Virox	ACCRESW-1, ACCWIP20-TBUS



MOBILITY
 Quickly attach the Disposable Wipe Bracket to the Pole Mount (BWX02-0412)



CONVENIENCE
 Attach Disposable Wipe Bracket directly to wall or cart

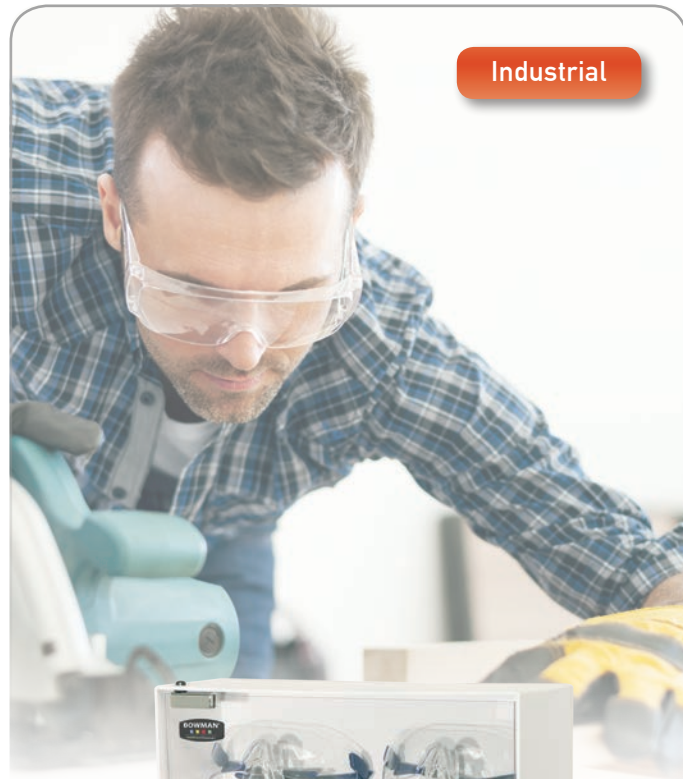

Industrial



CP-075 (ABS) (PET)

Eyewear Cabinet
Locking



CP-072 (PET)

Eyewear Dispenser
Hinged Lid



Food Service



TB-003 (CRS)

Towel Dispenser



HP-010 (PET)

Hairnet Dispenser

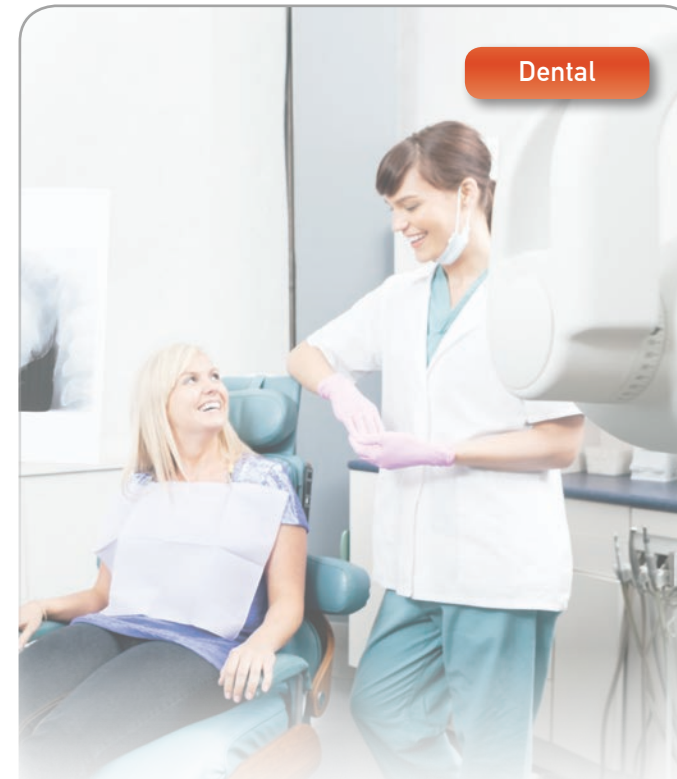

Dental



MD-100 (ABS) (PET)

Dental Organizer



Educational



ED-760 (STP) (PET)

Epinephrine Injector Dispenser

Holds 10 Epinephrine Injectors
Also available - ED-750 (Holds 5) (ABS) (PET)

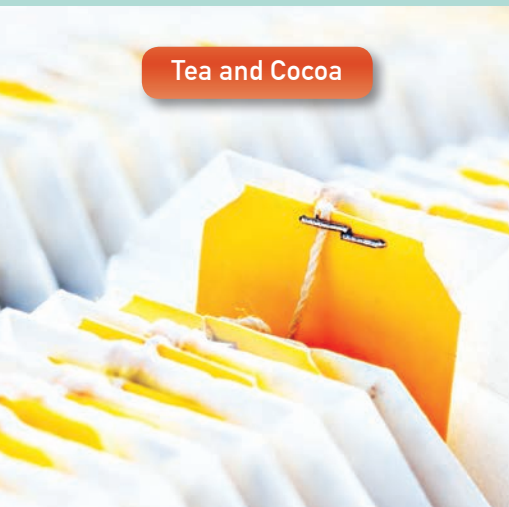

Tea and Cocoa



Small Shop Tools



Craft Supplies

Endless Possibilities

A Multitude of Storage and Organizing Options

- ✓ Balloons
- ✓ Batteries
- ✓ Buttons
- ✓ Condiments
- ✓ Condoms
- ✓ Cotton Balls
- ✓ Cotton Swabs
- ✓ Crayons
- ✓ Cream and Sugar Packets
- ✓ Erasers
- ✓ Fishing Bait/Tackle
- ✓ Glue Sticks
- ✓ Granola Bars
- ✓ Hair Accessories
- ✓ Hardware
- ✓ Hot Chocolate Packets
- ✓ Individual Diapers
- ✓ Lip Balms/Lipsticks
- ✓ Magnets
- ✓ Makeup
- ✓ Makeup Applicators
- ✓ Nail Polish
- ✓ Oatmeal Packets
- ✓ Single Dose Medicine Packets
- ✓ Small Measuring Tapes
- ✓ Small Soaps
- ✓ Small Moisturizers, Lotions, and Sun Block
- ✓ Small Cars & Toys
- ✓ Sticky Notes
- ✓ Tampons
- ✓ Tea Bag Packets
- ✓ Tea Light Candles
- ✓ Thread Spools
- ✓ Towelettes/Wipes
- ✓ Travel/Sample Size Sundries



BP-011
Grocery Bags



BP-012
Personal Coffee Pods



BP-090
Candy



RS001-0512
Gowns or Gloves



GN100-0212
Wipes



KS122-0529
Gloves



GL100-0212
Tissues



PD100-0212
Diapers

BALLOONS
Buttons
Towels
TOYS, THREAD
condiments
HARDWARE
cotton swabs
FISHING BAIT
CREAM & SUGAR PACKETS
TAMPONS soaps
diapers



ED-097
Gloves



Toys and Crayons





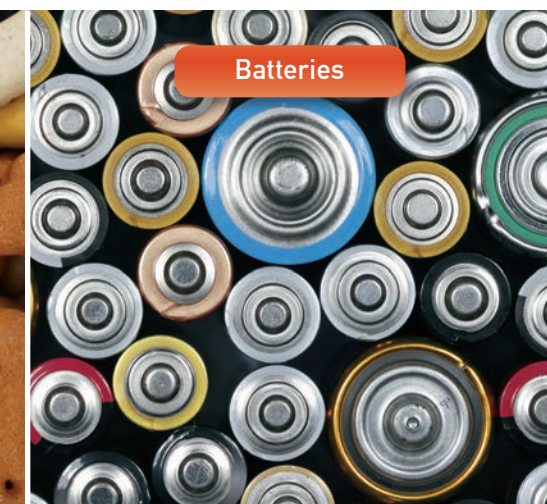



Dog Treats



Batteries

BOWMAN Dispensers are crafted from the most durable materials available

Properties Comparison	Example	Long Term Durability	Impact Resistance	Chemical Resistance	Optical Properties
ABS Plastic (Quartz Beige or White)		Very Good	Very Good	Very Good	N/A
Coated-Wire (White)		Good	Good	Very Good	N/A
Fauxwood ABS Plastic (Cherry Or Maple)		Very Good	Very Good	Very Good	N/A
PETG Plastic (Clear)		Excellent	Very Good	Very Good	Very Good
Polycarbonate Plastic (Frosted Clear)		Excellent	Excellent	Excellent	Fair
Powder-Coated Aluminum (Bay Gray or Quartz Beige)		Good	Good	Good	N/A
Powder-Coated Steel (Bay Gray, Black, Quartz Beige, or White)		Excellent	Excellent	Good	N/A
Stainless Steel (Metal)		Excellent	Excellent	Excellent	N/A
Sintra Plastic (White or Yellow)		Excellent	Very Good	Good	N/A

Product Number Guide Example









PS016-0212 =
Protection System, Model 016, ABS, Quartz Beige



BOWMAN Materials⁷

- ABS** ABS Plastic **02**
- CRS** Cold Rolled Steel **04**
- STP** Sintra® Plastic **07**
- AFP** ABS Fauxwood Plastic **02**
- PET** PETG Plastic **01**
- STS** Stainless Steel **03**
- ALM** Aluminum **05**
- PLC** Polycarbonate Plastic **12**
- WIR** Powder-Coated Wire **06**

BOWMAN Colors⁷

-  Bay Gray **29**
-  Clear **11**
-  Quartz Beige **12**
-  Black **20**
-  Frosted Clear **14**
-  Stainless Steel **00**
-  Cherry **33**
-  Maple **23**
-  White **13, 34**

⁷Colors may vary. Not all colors or materials are available for all dispensers. Use the material codes shown in this catalog as a reference for what a particular dispenser is made from. Custom options are also available. Call BOWMAN or check with your distributor if you have questions.

PRIVATE LABELING OPTIONS

Promote your brand with BOWMAN Dispensers. You have the option to add custom information, including your company name or logo, and up to three lines of text.

Program Details:

- One time minimal set up fee
- No additional costs thereafter
- One color of your choice
- Call our Customer Service department at 800-962-4660 for more information

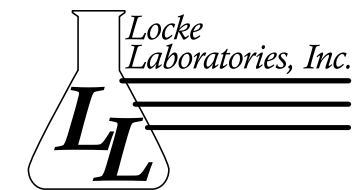

Part Number	Product Name	Page	Unit	W (L)	H	D	Product Weight
BB-034	Bouffant Cap or Shoe Cover Dispenser - White Powder-Coated Steel	62	IN	10.06	10.00	5.31	LB 2.2
			CM	25.6	25.4	13.5	KG 1.0
BD101-0012	Cover Your Cough Compliance Kit with Vertical Sign Holder - Includes: RS001-0512, KS010-0412, MP-070	32	IN	18.00	59.10	18.00	LB 20.7
			CM	45.7	150.1	45.7	KG 9.4
BD102-0012	Cover Your Cough Compliance Kit with Horizontal Sign Holder - Includes: RS001-0512, KS010-0412, MP-075	32	IN	18.00	56.60	18.00	LB 20.7
			CM	45.7	143.8	45.7	KG 9.4
BD105-0012	Cover Your Cough Compliance Kit - Locking with Vertical Sign Holder - Includes: RS005-0512, KS010-0412, MP-070	32	IN	18.00	60.48	18.00	LB 22.0
			CM	45.7	153.6	45.7	KG 10.0
BD106-0012	Cover Your Cough Compliance Kit - Locking with Horizontal Sign Holder - Includes: RS005-0512, KS010-0412, MP-075	32	IN	18.00	57.98	18.00	LB 22.0
			CM	45.7	147.3	45.7	KG 10.0
BD111-0012	Cover Your Cough Compliance Kit with Vertical Sign Holder - Includes: RS001-0212, KS010-0412, MP-070	32	IN	18.00	58.36	18.00	LB 19.2
			CM	45.7	148.2	45.7	KG 8.7
BD112-0012	Cover Your Cough Compliance Kit with Horizontal Sign Holder - Includes: RS001-0212, KS010-0412, MP-075	32	IN	18.00	55.86	18.00	LB 19.3
			CM	45.7	141.9	45.7	KG 8.8
BD201-0012	Cover Your Cough Compliance Kit with Vertical Sign Holder - Includes: RS001-0512, MP-070	32	IN	17.90	23.04	5.14	LB 4.7
			CM	45.5	58.5	13.1	KG 2.1
BD202-0012	Cover Your Cough Compliance Kit with Horizontal Sign Holder - Includes: RS001-0512, MP-075	32	IN	17.90	20.54	5.14	LB 4.7
			CM	45.5	52.2	13.1	KG 2.1
BD205-0012	Cover Your Cough Compliance Kit - Locking with Vertical Sign Holder - Includes: RS005-0512, MP-070	32	IN	22.25	24.42	5.00	LB 6.0
			CM	56.5	62.0	12.7	KG 2.7
BD206-0012	Cover Your Cough Compliance Kit - Locking with Horizontal Sign Holder - Includes: RS005-0512, MP-075	32	IN	22.25	21.92	5.00	LB 6.0
			CM	56.5	55.7	12.7	KG 2.7
BD211-0012	Cover Your Cough Compliance Kit with Vertical Sign Holder - Includes: RS001-0212, MP-070	32	IN	17.90	22.30	4.45	LB 3.2
			CM	45.5	56.6	11.3	KG 1.5
BD212-0012	Cover Your Cough Compliance Kit with Horizontal Sign Holder - Includes: RS001-0212, MP-075	32	IN	17.90	19.80	4.45	LB 3.3
			CM	45.5	50.3	11.3	KG 1.5
BG001-0111	Bag Dispenser - Single - Clear PETG Plastic	78	IN	10.10	3.60	3.95	LB 0.7
			CM	25.7	9.1	10.0	KG 0.3
BG001-0212	Bag Dispenser - Single - Quartz Beige ABS Plastic	69	IN	10.10	3.60	3.95	LB 0.6
			CM	25.7	9.1	10.0	KG 0.2
BG001-0512	Bag Dispenser - Single - Quartz Beige Powder-Coated Aluminum	3, 11, 69	IN	10.05	3.50	3.88	LB 0.9
			CM	25.5	8.9	9.9	KG 0.4
BG002-0111	Bag Dispenser - Double - Clear PETG Plastic	78	IN	10.10	7.10	3.95	LB 1.2
			CM	25.7	18.0	10.0	KG 0.5
BG002-0212	Bag Dispenser - Double - Quartz Beige ABS Plastic	69	IN	10.10	7.10	3.95	LB 1.0
			CM	25.7	18.0	10.0	KG 0.4
BG002-0512	Bag Dispenser - Double - Quartz Beige Powder-Coated Aluminum	69	IN	10.05	7.00	3.90	LB 1.3
			CM	25.5	17.8	9.9	KG 0.6
BG008-0111	Bulk Dispenser - Flat Pack Bio Bag - Clear PETG Plastic	69	IN	6.20	11.10	3.20	LB 0.8
			CM	15.7	28.2	8.1	KG 0.4
BG009-0512	Bag Dispenser - Single - Large Capacity - Quartz Beige Powder-Coated Aluminum	69	IN	12.00	6.35	6.40	LB 1.6
			CM	30.5	16.1	16.3	KG 0.7
BK001-0300	Bulk Dispenser - Tall Single Bin - Stainless Steel	55	IN	12.21	17.07	5.76	LB 7.5
			CM	31.0	43.4	14.6	KG 3.4
BK002-0300	Bulk Dispenser - Single Bin - Stainless Steel	11, 54	IN	12.21	11.13	5.76	LB 5.3
			CM	31.0	28.3	14.6	KG 2.4
BP-007	Bouffant Cap or Shoe Cover Dispenser - Clear PETG Plastic	62	IN	11.39	11.23	5.26	LB 1.0
			CM	28.9	28.5	13.4	KG 0.5
BP-011	Bulk Dispenser - Tall Single Bin - Clear PETG Plastic	56, 74	IN	12.27	17.03	5.83	LB 3.2
			CM	31.2	43.3	14.8	KG 1.4

Part Number	Product Name	Page	Unit	W (L)	H	D	Product Weight
BP-012	Bulk Dispenser - Tall Double Bin - Clear PETG Plastic	57, 74	IN	12.27	17.00	5.77	LB 3.5
			CM	31.2	43.2	14.7	KG 1.6
BP-021	Bulk Dispenser - Single Bin - Clear PETG Plastic	8, 10, 56	IN	12.27	11.13	5.78	LB 2.2
			CM	31.2	28.3	14.7	KG 1.0
BP-022	Bulk Dispenser - Double Bin - Clear PETG Plastic	57, 60	IN	12.27	11.13	5.78	LB 2.4
			CM	31.2	28.3	14.7	KG 1.1
BP-023	Bulk Dispenser - Triple Bin - Clear PETG Plastic	57	IN	17.50	11.16	6.05	LB 3.5
			CM	44.5	28.4	15.4	KG 1.6
BP-090	Bulk Dispenser - Tall Triple Bin - Clear PETG Plastic	3, 5, 10, 57, 60, 74	IN	18.40	17.08	5.77	LB 5.0
			CM	46.7	43.4	14.7	KG 2.2
BW100-0212	Bottle Holder - Universal - Hand Gel - Quartz Beige ABS Plastic	33	IN	4.35	4.00	4.52	LB 0.3
			CM	11.0	10.2	11.5	KG 0.1
BWX01-0412	Disposable Wipe Bracket - Quartz Beige Powder-Coated Steel	71	IN	3.48	3.80	5.00	LB 0.6
			CM	8.8	9.7	12.7	KG 0.3
BWX02-0412	Disposable Wipe Bracket Pole Mount - For use with the BWX01-0412 - Quartz Beige Powder-Coated Steel	71	IN	1.55	2.55	3.00	LB 0.8
			CM	3.9	6.5	7.6	KG 0.4
CL002-0111	Task Wipe Dispenser - Small - Clear PETG Plastic	79	IN	5.20	5.10	3.20	LB 0.3
			CM	13.2	13.0	8.1	KG 0.1
CL003-0111	Task Wipe Dispenser - Large - Clear PETG Plastic	79	IN	5.20	15.85	3.95	LB 1.0
			CM	13.2	40.3	10.0	KG 0.5
CL006-0213	Scrub Brush Dispenser - White ABS Plastic	63	IN	5.08	9.10	5.33	LB 0.4
			CM	12.9	23.1	13.5	KG 0.2
CP-072	Eyewear Dispenser - Hinged Lid - Clear PETG Plastic	72	IN	9.25	3.45	6.91	LB 1.1
			CM	23.5	8.8	17.6	KG 0.5
CP-075	Eyewear Cabinet - Locking - White ABS Plastic with Clear PETG Plastic Locking Door	72	IN	13.50	20.00	4.13	LB 4.3
			CM	34.3	50.8	10.5	KG 1.9
ED-097	Infection Prevention System - Quartz Beige ABS Plastic & Clear PETG Plastic Sign Holder	10, 27, 75	IN	15.00	11.38	5.75	LB 1.8
			CM	38.1	28.9	14.6	KG 0.8
ED-750	Epinephrine Injector Dispenser - 5 Injector Capacity - Quartz Beige ABS Plastic & Clear PETG Plastic Door	73	IN	9.00	11.19	2.51	LB 1.9
			CM	22.9	28.4	6.4	KG 0.8
ED-760	Epinephrine Injector Dispenser - 10 Injector Capacity - Yellow Sintra® Plastic & Clear PETG Plastic	73	IN	9.49	11.19	4.65	LB 2.4
			CM	24.1	28.4	11.8	KG 1.1
FB-021	Face Mask Dispenser - Tie Style - White Powder-Coated Steel	46, 50, 51	IN	7.44	4.75	4.81	LB 0.9
			CM	18.9	12.1	12.2	KG 0.4
FB-037	Face Mask Dispenser - Earloop Style - White Powder-Coated Steel	46, 50, 51	IN	7.56	4.25	4.13	LB 0.7
			CM	19.2	10.8	10.5	KG 0.3
FB-040	Face Mask Dispenser - Tie Style - White Powder-Coated Steel	50, 51	IN	8.00	6.00	5.25	LB 1.3
			CM	20.3	15.2	13.3	KG 0.6
FB-063	Face Mask Dispenser - Tie Style - White Powder-Coated Steel	50, 51	IN	7.80	7.50	5.25	LB 1.4
			CM	19.8	19.1	13.3	KG 0.6
FB-064	Face Mask Dispenser - Earloop Style - White Powder-Coated Steel	50, 51	IN	7.56	4.25	4.13	LB 0.8
			CM	19.2	10.8	10.5	KG 0.3
FB-090	Face Mask Dispenser - Face Shield Style - White Powder-Coated Steel	46, 50, 51	IN	9.06	7.53	4.06	LB 1.2
			CM	23.0	19.1	10.3	KG 0.5
FB-091	Face Mask Dispenser - Tie Style - White Powder-Coated Steel	50, 51	IN	7.90	7.70	5.00	LB 1.2
			CM	20.1	19.6	12.7	KG 0.5
FD-005	Face Mask Dispenser - Earloop Style - Bulk - White ABS Plastic & Clear PETG Plastic	46	IN	8.66	4.98	4.38	LB 1.0
			CM	22.0	12.6	11.1	KG 0.4
FD-062	Respiratory Hygiene Station - Locking - Quartz Beige ABS Plastic & Clear PETG Plastic Lid	79	IN	17.50	10.00	5.00	LB 3.2
			CM	44.5	25.4	12.7	KG 1.5

Part Number	Product Name	Page	Unit	W(L)	H	D	Product Weight	
FD-068	Infection Prevention System - Quartz Beige ABS Plastic	10, 26	IN	18.50	11.63	4.50	LB	2.1
			CM	47.0	29.5	11.4	KG	0.9
FD-111	Respiratory Hygiene Station - Quartz Beige ABS Plastic (Aluminum Version RS004-0512)	32	IN	19.75	13.88	5.00	LB	1.9
			CM	50.2	35.3	12.7	KG	0.8
FD-112	Respiratory Hygiene Station - Locking - Quartz Beige ABS Plastic (Aluminum Version RS005-0512)	32	IN	19.75	13.88	5.45	LB	2.7
			CM	50.2	35.3	13.8	KG	1.2
FM001-0213	Face Mask Dispenser - Surgical with Dividers - White ABS Plastic	63	IN	26.50	12.75	10.62	LB	8.9
			CM	67.3	32.4	27.0	KG	4.0
FM002-0213	Face Mask Dispenser - Combo or Protection System - Compact - White ABS Plastic	10, 18, 24, 47	IN	10.60	23.50	4.95	LB	2.7
			CM	26.9	59.7	12.6	KG	1.2
FM004-0213	Face Mask Dispenser - Surgical with Dividers and Three MP-035 Sign Holders - White ABS Plastic & Clear PETG Plastic	47	IN	26.50	20.69	10.62	LB	10.8
			CM	67.3	52.5	27.0	KG	4.9
FM100-0212	Face Mask Dispenser - Universal Boxed - Earloop - Quartz Beige ABS Plastic	11, 46, 48	IN	8.25	4.63	5.75	LB	0.5
			CM	21.0	11.8	14.6	KG	0.2
FM200-0212	Face Mask Dispenser - Universal Boxed - Face Shield - Quartz Beige ABS Plastic	3, 46, 48	IN	9.75	8.63	4.75	LB	1.0
			CM	24.8	21.9	12.1	KG	0.5
FM300-0212	Face Mask Dispenser - Universal Boxed - Cone - Quartz Beige ABS Plastic	3, 46, 48	IN	6.75	7.13	5.75	LB	0.7
			CM	17.1	18.1	14.6	KG	0.3
FP-017	Face Mask Dispenser - Bulk - Cone or Pre-Assembled Eye Shields - Clear PETG Plastic	46, 62	IN	6.70	8.98	6.04	LB	1.4
			CM	17.0	22.8	15.3	KG	0.6
FP-021	Face Mask Dispenser - Earloop Style - Clear PETG Plastic	52, 53	IN	7.95	4.23	5.20	LB	0.5
			CM	20.2	10.7	13.2	KG	0.2
FP-022	Face Mask Dispenser - Earloop Style - Clear PETG Plastic	52, 53	IN	8.12	7.72	4.91	LB	0.9
			CM	20.6	19.6	12.5	KG	0.4
FP-038	Face Mask Dispenser - Earloop Style - Clear PETG Plastic	52, 53	IN	7.70	4.32	4.27	LB	0.4
			CM	19.6	11.0	10.8	KG	0.2
FP-120	Face Mask Dispenser - Shield Style - Clear PETG Plastic	52, 53	IN	9.20	7.50	4.20	LB	0.7
			CM	23.4	19.1	10.7	KG	0.3
FP-121	Face Mask Dispenser - Earloop Style - Clear PETG Plastic	52, 53	IN	7.70	4.35	4.13	LB	0.5
			CM	19.6	11.0	10.5	KG	0.2
FP-122	Face Mask Dispenser - Tie Style - Clear PETG Plastic	52, 53	IN	8.08	7.60	5.58	LB	0.8
			CM	20.5	19.3	14.2	KG	0.3
FS001-0111	Wax Paper Dispenser - Clear PETG Plastic	80	IN	6.20	10.35	2.75	LB	0.7
			CM	15.7	26.3	7.0	KG	0.3
FS001-0300	Wax Paper Dispenser - Stainless Steel	80	IN	6.06	10.29	2.62	LB	1.4
			CM	15.4	26.1	6.7	KG	0.6
GB-001	Glove Box Dispenser - Single Flexible Spring - White Powder-Coated Steel	3, 39, 40	IN	5.60	9.96	3.80	LB	1.4
			CM	14.2	25.3	9.7	KG	0.6
GB-002	Glove Box Dispenser - Double - White Powder-Coated Steel	40	IN	10.56	10.03	3.81	LB	1.6
			CM	26.8	25.5	9.7	KG	0.7
GB-003	Glove Box Dispenser - Triple - White Powder-Coated Steel	40	IN	15.81	10.03	3.81	LB	1.8
			CM	40.2	25.5	9.7	KG	0.8
GB-059	Glove Box Dispenser - Quad - White Powder-Coated Steel	40	IN	22.32	9.99	3.81	LB	2.7
			CM	56.7	25.4	9.7	KG	1.2
GB-067	Glove Box Dispenser - Double - Space Saver - White Powder-Coated Steel	43	IN	5.60	20.04	3.94	LB	2.5
			CM	14.2	50.9	10.0	KG	1.1
GB-068	Glove Box Dispenser - Triple - Space Saver - White Powder-Coated Steel	43	IN	5.50	30.04	3.94	LB	3.5
			CM	14.0	76.3	10.0	KG	1.6
GB-074	Glove Box Dispenser - Single - Large Capacity with Flexible Spring - White Powder-Coated Steel	80	IN	6.50	9.96	3.80	LB	1.6
			CM	16.5	25.3	9.7	KG	0.7

Part Number	Product Name	Page	Unit	W(L)	H	D	Product Weight	
GB-144	Glove Box Dispenser - Single with Flexible Spring - Cabinet Mount - White Powder-Coated Steel	6, 44	IN	5.60	10.00	3.80	LB	1.4
			CM	14.2	25.4	9.7	KG	0.6
GC-009	Glove Dispenser - Bulk - White Sintra® Plastic	81	IN	5.05	11.21	4.45	LB	0.6
			CM	12.8	28.5	11.3	KG	0.3
GC-018	Glove Box Dispenser - Single with Flexible Spring - White Sintra® Plastic	81	IN	5.80	10.06	4.07	LB	0.5
			CM	14.7	25.6	10.3	KG	0.2
GL002-0413	Glove Box Dispenser - Double with Dividers - White Powder-Coated Steel	3, 39	IN	10.60	10.03	3.82	LB	2.3
			CM	26.9	25.5	9.7	KG	1.0
GL003-0413	Glove Box Dispenser - Triple with Dividers - White Powder-Coated Steel	39	IN	15.87	10.03	3.81	LB	2.3
			CM	40.3	25.5	9.7	KG	1.0
GL004-0413	Glove Box Dispenser - Quad with Dividers - White Powder-Coated Steel	39	IN	21.19	10.00	3.81	LB	2.4
			CM	53.8	25.4	9.7	KG	1.1
GL010-0223	Glove Box Dispenser - Single - Maple Fauxwood ABS Plastic	38	IN	5.75	10.13	4.00	LB	0.8
			CM	14.6	25.7	10.2	KG	0.4
GL010-0233	Glove Box Dispenser - Single - Cherry Fauxwood ABS Plastic	13, 38	IN	5.75	10.13	4.00	LB	0.8
			CM	14.6	25.7	10.2	KG	0.4
GL011-0613*	Glove Box Dispenser - Single - White Coated-Wire	40	IN	5.67	8.16	3.75	LB	0.7
			CM	14.4	20.7	9.5	KG	0.3
GL020-0111	Glove Box Dispenser - Double with Dividers - Clear PETG Plastic	39	IN	11.38	10.13	4.00	LB	1.2
			CM	28.9	25.7	10.2	KG	0.5
GL020-0212	Glove Box Dispenser - Double with Dividers - Quartz Beige ABS Plastic	38	IN	11.38	10.13	4.00	LB	1.2
			CM	28.9	25.7	10.2	KG	0.5
GL020-0223	Glove Box Dispenser - Double with Dividers - Maple Fauxwood ABS Plastic	13, 38	IN	11.38	10.13	4.00	LB	1.2
			CM	28.9	25.7	10.2	KG	0.5
GL020-0233	Glove Box Dispenser - Double with Dividers - Cherry Fauxwood ABS Plastic	38	IN	11.38	10.13	4.00	LB	1.2
			CM	28.9	25.7	10.2	KG	0.5
GL022-0613*	Glove Box Dispenser - Double - White Coated-Wire	40	IN	10.97	8.16	3.75	LB	1.0
			CM	27.9	20.7	9.5	KG	0.4
GL030-0223	Glove Box Dispenser - Triple with Dividers - Maple Fauxwood ABS Plastic	3, 5, 10, 38	IN	17.00	10.13	4.00	LB	1.4
			CM	43.2	25.7	10.2	KG	0.6
GL030-0233	Glove Box Dispenser - Triple with Dividers - Cherry Fauxwood ABS Plastic	9, 13, 38	IN	17.00	10.13	4.00	LB	1.4
			CM	43.2	25.7	10.2	KG	0.6
GL033-0613*	Glove Box Dispenser - Triple - White Coated-Wire	40	IN	16.32	8.16	3.75	LB	1.3
			CM	41.5	20.7	9.5	KG	0.6
GL040-0111	Glove Box Dispenser - Quad with Dividers - Clear PETG Plastic	39	IN	22.63	10.13	4.00	LB	1.9
			CM	57.5	25.7	10.2	KG	0.8
GL040-0212	Glove Box Dispenser - Quad with Dividers - Quartz ABS Plastic	38	IN	22.63	10.13	4.00	LB	1.9
			CM	57.5	25.7	10.2	KG	0.8
GL040-0223	Glove Box Dispenser - Quad with Dividers - Maple Fauxwood ABS Plastic	13, 38	IN	22.63	10.13	4.00	LB	1.9
			CM	57.5	25.7	10.2	KG	0.8
GL040-0233	Glove Box Dispenser - Quad with Dividers - Cherry Fauxwood ABS Plastic	11, 38	IN	22.63	10.13	4.00	LB	1.9
			CM	57.5	25.7	10.2	KG	0.8
GL044-0613*	Glove Box Dispenser - Quad - White Coated-Wire	40	IN	21.67	8.16	3.75	LB	1.6
			CM	55.0	20.7	9.5	KG	0.7
GL100-0212	Glove Box Dispenser - Single with Flexible Springs - Quartz Beige ABS Plastic	36, 38, 75	IN	5.84	10.11	4.22	LB	0.7
			CM	14.8	25.7	10.7	KG	0.3
GL100-1214	Glove Box Dispenser - Single with Flexible Springs - Semi-Transparent Polycarbonate Plastic	36, 39	IN	5.84	10.11	4.22	LB	0.7
			CM	14.8	25.7	10.7	KG	0.3
GL102-0111	Glove Box Dispenser - Single - Food Service - Narrow - Clear PETG Plastic	42	IN	5.08	9.10	2.95	LB	0.5
			CM	12.9	23.1	7.5	KG	0.2

Part Number	Product Name	Page	Unit	W (L)	H	D	Product Weight
GL102-0300	Glove Box Dispenser - Single - Food Service - Narrow - Stainless Steel	42	IN	4.95	9.04	2.82	LB 1.2
			CM	12.6	23.0	7.2	KG 0.5
GL300-0212	Glove Box Dispenser - Triple with Dividers - Quartz Beige ABS Plastic	37, 38	IN	17.08	10.11	4.22	LB 1.4
			CM	43.4	25.7	10.7	KG 0.6
GL300-1214	Glove Box Dispenser - Triple with Dividers - Semi-Transparent Polycarbonate Plastic	6, 37, 39, 41, 44	IN	17.08	10.11	4.22	LB 1.4
			CM	43.4	25.7	10.7	KG 0.6
GN001-0212	Gown Dispenser - Bulk - Quartz Beige ABS Plastic	58	IN	14.70	15.12	5.04	LB 2.7
			CM	37.3	38.4	12.8	KG 1.2
GN100-0212	Gown Dispenser - Universal Boxed Thumb Loop - Quartz Beige ABS Plastic	59, 75	IN	7.95	9.85	4.95	LB 1.0
			CM	20.2	25.0	12.6	KG 0.5
GP-013	Glove Box Dispenser - Single with Flexible Spring - Clear PETG Plastic	40	IN	5.70	9.85	3.95	LB 0.7
			CM	14.5	25.0	10.0	KG 0.3
GP-014	Glove Box Dispenser - Double - Clear PETG Plastic	40	IN	10.70	10.10	3.95	LB 0.9
			CM	27.2	25.7	10.0	KG 0.4
GP-015	Glove Box Dispenser - Triple - Clear PETG Plastic	40	IN	15.95	10.10	3.95	LB 1.0
			CM	40.5	25.7	10.0	KG 0.4
GP-020	Glove Box Dispenser - Single - Large Capacity with Flexible Spring - Clear PETG Plastic	82	IN	6.64	10.03	4.01	LB 0.9
			CM	16.9	25.5	10.2	KG 0.4
GP-061	Glove Box Dispenser - Quad - Clear PETG Plastic	40	IN	22.45	10.03	3.88	LB 1.2
			CM	57.0	25.5	9.9	KG 0.5
GP-071	Glove Box Dispenser - Single - Narrow - Clear PETG Plastic	42	IN	5.70	9.85	2.95	LB 0.7
			CM	14.5	25.0	7.5	KG 0.3
GP-072	Glove Box Dispenser - Double - Narrow - Clear PETG Plastic	42	IN	10.70	10.10	2.95	LB 0.8
			CM	27.2	25.7	7.5	KG 0.3
GP-073	Glove Box Dispenser - Triple - Narrow - Clear PETG Plastic	42	IN	15.95	10.10	2.95	LB 0.9
			CM	40.5	25.7	7.5	KG 0.4
GP-106	Glove Box Dispenser - Double - Space Saver - Clear PETG Plastic	43	IN	5.70	20.10	4.08	LB 1.4
			CM	14.5	51.1	10.4	KG 0.6
GP-107	Glove Box Dispenser - Triple - Space Saver - Clear PETG Plastic	43	IN	5.50	30.11	3.94	LB 2.0
			CM	14.0	76.5	10.0	KG 0.9
GP-310	Glove Box Dispenser - Single - Clear PETG Plastic	43	IN	11.20	4.85	3.70	LB 0.7
			CM	28.4	12.3	9.4	KG 0.3
GP-320	Glove Box Dispenser - Double - Clear PETG Plastic	43	IN	11.20	9.60	3.70	LB 1.2
			CM	28.4	24.4	9.4	KG 0.5
GP-330	Glove Box Dispenser - Triple - Clear PETG Plastic	43	IN	11.20	14.35	3.70	LB 1.7
			CM	28.4	36.4	9.4	KG 0.7
GP-340	Glove Box Dispenser - Quad - Clear PETG Plastic	43	IN	11.20	19.10	3.70	LB 2.3
			CM	28.4	48.5	9.4	KG 1.0
GS-004	Glove Box Dispenser - Single with Flexible Spring - Stainless Steel	39, 40	IN	5.60	9.96	3.80	LB 1.4
			CM	14.2	25.3	9.7	KG 0.6
GS-005	Glove Box Dispenser - Double - Stainless Steel	40	IN	10.56	10.04	3.82	LB 1.4
			CM	26.8	25.5	9.7	KG 0.6
GS-006	Glove Box Dispenser - Triple - Stainless Steel	40	IN	15.82	10.04	3.79	LB 1.8
			CM	40.2	25.5	9.6	KG 0.8
GS-060	Glove Box Dispenser - Quad - Stainless Steel	40	IN	22.32	9.99	3.81	LB 2.4
			CM	56.7	25.4	9.7	KG 1.1
GS-073	Glove Box Dispenser - Single - Large Capacity with Flexible Spring - Stainless Steel	82	IN	6.50	9.96	3.80	LB 1.5
			CM	16.5	25.3	9.7	KG 0.7
GS-108	Glove Box Dispenser - Double - Space Saver - Stainless Steel	43	IN	5.60	20.03	3.94	LB 2.4
			CM	14.2	50.9	10.0	KG 1.1

Part Number	Product Name	Page	Unit	W (L)	H	D	Product Weight
GS-109	Glove Box Dispenser - Triple - Space Saver - Stainless Steel	43	IN	5.50	30.04	3.94	LB 3.6
			CM	14.0	76.3	10.0	KG 1.6
GS-122	Glove Box Dispenser - Double with Divider - Stainless Steel	39	IN	10.59	10.03	3.81	LB 1.8
			CM	26.9	25.5	9.7	KG 0.8
GS-123	Glove Box Dispenser - Triple with Dividers - Stainless Steel	39	IN	15.87	10.03	3.81	LB 2.3
			CM	40.3	25.5	9.7	KG 1.0
GS-124	Glove Box Dispenser - Quad with Dividers - Stainless Steel	39	IN	21.16	10.03	3.81	LB 2.4
			CM	53.7	25.5	9.7	KG 1.1
HP-010	Hairnet Dispenser - Bulk - Clear PETG Plastic	3, 72	IN	4.45	7.98	3.92	LB 0.7
			CM	11.3	20.3	10.0	KG 0.3
KS010-0412	Floor Stand - All Steel - Quartz Beige Powder-Coated Steel	31, 32	IN	18.00	36.06	18.00	LB 16.0
			CM	45.7	91.6	45.7	KG 7.3
KS010-0420	Floor Stand - All Steel - Black Powder-Coated Steel	13, 31	IN	18.00	36.06	18.00	LB 16.0
			CM	45.7	91.6	45.7	KG 7.3
KS010-0434	Floor Stand - All Steel - Matte White Powder-Coated Steel	31	IN	18.00	36.06	18.00	LB 16.0
			CM	45.7	91.6	45.7	KG 7.3
KS101-0029*	Hand Sanitizer Floor Stand - Bay Gray Steel Back Plate, Column, and Base	3, 34, 35	IN	18.00	54.73	18.00	LB 16.0
			CM	45.7	139.0	45.7	KG 7.3
KS102-0029*	Hand Sanitizer Floor Stand - Bay Gray Steel Back Plate, Column, and Base - Quartz Beige ABS Plastic Drip Tray	34	IN	18.00	54.73	18.00	LB 16.3
			CM	45.7	139.0	45.7	KG 7.4
KS122-0529	Infection Prevention Station - Bay Gray Powder-Coated Aluminum	34, 75	IN	7.21	15.11	4.29	LB 2.0
			CM	18.3	38.4	10.9	KG 0.9
KS123-0529	Infection Prevention Station Accessory for Hand Sanitizer Floor Stand - Bay Gray Powder-Coated Aluminum	34	IN	7.21	15.11	4.29	LB 2.0
			CM	18.3	38.4	10.9	KG 0.9
KS201-0029*	Floor Stand - Bay Gray Powder-Coated Steel Mounting Plate, Column, and Base	83	IN	18.00	36.73	18.00	LB 15.3
			CM	45.7	93.3	45.7	KG 6.9
LD-007	Protection System - Quartz Beige ABS Plastic (Aluminum Version PS021-0512)	18, 25	IN	16.63	25.25	4.50	LB 3.9
			CM	42.2	64.1	11.4	KG 1.7
LD-037	Protection System - Quartz Beige ABS Plastic (Aluminum Version PS022-0512)	18, 25	IN	23.50	20.80	4.75	LB 5.6
			CM	59.7	52.8	12.1	KG 2.5
LD-064	Protection System - 4" Deep - Quartz Beige ABS Plastic	18, 24	IN	16.75	25.63	4.00	LB 3.7
			CM	42.5	65.1	10.2	KG 1.7
LD-070	Protection System - Quartz Beige ABS Plastic	83	IN	20.05	25.25	4.75	LB 4.3
			CM	50.9	64.1	12.1	KG 2.0
LP-004	Protection System - Surgical - Quartz Beige ABS Plastic & Clear PETG Plastic (Aluminum Version PS023-0512)	62	IN	22.15	19.68	4.88	LB 4.8
			CM	56.3	50.0	12.4	KG 2.2
MB-450	Hanger - Metal Bracketed Fire Door - Quartz Beige Powder-Coated Steel	23	IN	26.14	29.49	2.92	LB 2.5
			CM	66.4	74.9	7.4	KG 1.1
MB-500	Hanger - Glass Door - Quartz Beige Powder-Coated Steel	23	IN	22.00	4.62	0.56	LB 1.0
			CM	55.9	11.7	1.4	KG 0.4
MB-510	Hanger - Wall - Quartz Beige Powder-Coated Steel	22	IN	5.50	2.62	0.56	LB 0.2
			CM	14.0	6.7	1.4	KG 0.1
MB-600	Hanger - Door - Standard - Quartz Beige Powder-Coated Steel	23	IN	5.50	12.13	2.50	LB 1.1
			CM	14.0	30.8	6.4	KG 0.5
MB-601	Hanger - Door - Long - Quartz Beige Powder-Coated Steel	23	IN	5.50	19.00	2.50	LB 1.4
			CM	14.0	48.3	6.4	KG 0.6
MD-100	Dental Organizer - Quartz Beige ABS Plastic & Clear PETG Plastic	3, 73	IN	17.61	23.50	5.08	LB 4.4
			CM	44.7	59.7	12.9	KG 2.0
MP-015	Caddy Dispenser - Clip-On - Clear PETG Plastic	19, 25	IN	6.20	7.33	6.65	LB 0.9
			CM	15.7	18.6	16.9	KG 0.4

Part Number	Product Name	Page	Unit	W(L)	H	D	Product Weight
MP-035	Sign Holder for FM001-0213 - Clear PETG Plastic	47, 63	IN	8.50	11.19	0.38	LB 0.9
			CM	21.6	28.4	1.0	KG 0.4
MP-047	Sign Holder - Clip-On - Clear PETG Plastic	15, 19, 21, 22, 24	IN	8.50	11.19	0.63	LB 0.9
			CM	21.6	28.4	1.6	KG 0.4
MP-070	Sign Holder - Vertical - Respiratory Hygiene Station - Clear PETG Plastic	3, 10, 11, 13, 28, 29, 31, 32, 33	IN	8.63	13.79	0.33	LB 1.1
			CM	21.9	35.0	0.8	KG 0.5
MP-075	Sign Holder - Horizontal - Respiratory Hygiene Station - Clear PETG Plastic	10, 13, 27, 29, 31, 32, 33	IN	11.25	11.29	0.33	LB 1.2
			CM	28.6	28.7	0.8	KG 0.5
MP-085	Caddy Dispenser - Clip-On - Clear PETG Plastic	19, 25	IN	4.80	8.10	5.05	LB 0.9
			CM	12.2	20.6	12.8	KG 0.4
MW-001*	Biohazard Bag Holder - 1 Gallon - White Coated-Wire	10, 68	IN	9.50	12.88	6.25	LB 1.7
			CM	24.1	32.7	15.9	KG 0.7
MW-003*	Biohazard Bag Holder - 3 Gallon - White Coated-Wire	68	IN	11.75	15.25	8.00	LB 2.1
			CM	29.8	38.7	20.3	KG 1.0
MW-005*	Biohazard Bag Holder - 5 Gallon - White Coated-Wire	68	IN	13.50	19.50	8.50	LB 2.7
			CM	34.3	49.5	21.6	KG 1.2
NC001-0512	Bedpan/Urinal Dispenser - Quartz Beige Powder-Coated Aluminum	5, 10, 70	IN	12.33	12.00	4.66	LB 1.9
			CM	31.3	30.5	11.8	KG 0.8
PD003-0111	Protection Dispenser - Eye Shield - Clear PETG Plastic	62	IN	6.00	12.00	7.40	LB 1.4
			CM	15.2	30.5	18.8	KG 0.6
PD100-0212	Protection Dispenser - Universal Boxed - Shoe Cover/Cap/Other - Quartz Beige ABS Plastic	10, 65, 66, 75	IN	12.25	10.13	7.63	LB 1.1
			CM	31.1	25.7	19.4	KG 0.5
PD200-0212	Protection Dispenser - Universal Boxed - Shoe Cover/Cap/Other - Large - Quartz Beige ABS Plastic	64, 66	IN	12.50	10.13	9.88	LB 1.1
			CM	31.8	25.7	25.1	KG 0.5
PD300-0212	Protection Dispenser - Universal Boxed - Shoe Cover/Cap/Other - Quartz Beige ABS Plastic	65, 66	IN	13.70	5.73	6.95	LB 1.0
			CM	34.8	14.6	17.7	KG 0.5
PS004-0111	Protection System - Glove & Bag - Clear PETG Plastic	69	IN	10.10	20.40	3.95	LB 1.2
			CM	25.7	51.8	10.0	KG 0.5
PS004-0212	Protection System - Glove & Bag - Quartz Beige ABS Plastic	69	IN	10.10	20.40	3.95	LB 1.3
			CM	25.7	51.8	10.0	KG 0.6
PS012-0512	Protection System - Quad Glove - Quartz Beige Powder-Coated Aluminum	84	IN	22.75	25.63	4.58	LB 7.3
			CM	57.8	65.1	11.6	KG 3.3
PS014-0212	Protection System - Gloveless - Quartz Beige ABS Plastic	84	IN	23.38	14.98	4.75	LB 4.2
			CM	59.4	38.0	12.1	KG 1.9
PS015-0212	Protection System - Double Gown - Quartz Beige ABS Plastic	18, 25	IN	25.15	30.75	4.75	LB 9.4
			CM	63.9	78.1	12.1	KG 4.3
PS015-0512	Protection System - Double Gown - Quartz Beige Powder-Coated Aluminum	18, 24	IN	25.05	30.75	4.65	LB 11.0
			CM	63.6	78.1	11.8	KG 5.0
PS016-0111	Protection System - Clear PETG Plastic	16, 25	IN	23.38	26.63	4.75	LB 3.1
			CM	59.4	67.6	12.1	KG 1.4
PS016-0212	Protection System - Quartz Beige ABS Plastic	16, 22, 25	IN	23.38	26.63	4.75	LB 7.7
			CM	59.4	67.6	12.1	KG 3.5
PS016-0223	Protection System - Maple Fauxwood ABS Plastic	10, 12, 16, 19, 25	IN	23.38	26.63	4.75	LB 7.8
			CM	59.4	67.6	12.1	KG 3.5
PS016-0233	Protection System - Cherry Fauxwood ABS Plastic	12, 17, 19, 22, 25	IN	23.38	26.63	4.75	LB 7.8
			CM	59.4	67.6	12.1	KG 3.5
PS016-0300	Protection System - Stainless Steel	17, 25	IN	22.75	25.63	4.52	LB 13.2
			CM	57.8	65.1	11.5	KG 6.0
PS016-0512	Protection System - Quartz Beige Powder-Coated Aluminum	3, 10, 15, 17, 19, 21, 23, 24	IN	22.75	25.63	4.58	LB 7.6
			CM	57.8	65.1	11.6	KG 3.4

Part Number	Product Name	Page	Unit	W(L)	H	D	Product Weight
PS017-0212	Protection System - Surgical - Clear PETG Plastic & Quartz Beige ABS Plastic	10, 61	IN	25.00	30.19	6.75	LB 11.7
			CM	63.5	76.7	17.1	KG 5.3
PS021-0512	Protection System - Quartz Beige Powder-Coated Aluminum (ABS Version LD-007)	18, 24	IN	16.48	25.18	4.35	LB 5.9
			CM	41.8	63.9	11.0	KG 2.7
PS022-0512	Protection System - Quartz Beige Powder-Coated Aluminum (ABS Version LD-037)	18, 24	IN	22.75	20.23	4.58	LB 6.1
			CM	57.8	51.4	11.6	KG 2.7
PS023-0512	Protection System - Surgical - Quartz Beige Powder-Coated Aluminum (ABS/PETG Version LP-004)	62	IN	22.10	16.53	4.76	LB 6.6
			CM	56.1	42.0	12.1	KG 3.0
RE101-0012	Recessed PPE Dispensing System - Quartz Beige Powder-Coated Aluminum	7	IN	Call for more information			LB 22.4
			CM	Call for more information			KG 10.1
RE301-0012	Recessed Glove Box Dispenser - Triple - Quartz Beige Powder-Coated Aluminum	7	IN	Call for more information			LB 9.4
			CM	Call for more information			KG 4.2
RG-006	Quick Reference Card for Transmission Based Precautions - Horizontal - PVC Plastic	20, 21	IN	3.38	2.13	0.06	LB 0.0
			CM	8.6	5.4	0.2	KG 0.0
RG-008	Quick Reference Card for Transmission Based Precautions - Vertical - PVC Plastic	20	IN	2.13	3.38	0.06	LB 0.0
			CM	5.4	8.6	0.2	KG 0.0
RS001-0212	Respiratory Hygiene Station - Quartz Beige ABS Plastic	29, 31, 32	IN	17.90	10.50	4.45	LB 2.1
			CM	45.5	26.7	11.3	KG 1.0
RS001-0223	Respiratory Hygiene Station - Maple Fauxwood ABS Plastic	13, 31	IN	17.90	10.50	4.45	LB 1.7
			CM	45.5	26.7	11.3	KG 0.8
RS001-0233	Respiratory Hygiene Station - Cherry Fauxwood ABS Plastic	3, 10, 13, 31	IN	17.90	10.50	4.45	LB 1.7
			CM	45.5	26.7	11.3	KG 0.8
RS001-0512	Respiratory Hygiene Station - Quartz Beige Powder-Coated Aluminum	11, 29, 31, 32, 75	IN	17.90	11.75	5.14	LB 3.6
			CM	45.5	29.8	13.1	KG 1.6
RS002-0212	Respiratory Hygiene Station - Locking - Quartz Beige ABS Plastic	33	IN	13.80	12.65	5.30	LB 2.0
			CM	35.1	32.1	13.5	KG 0.9
RS002-0512	Respiratory Hygiene Station - Locking - Quartz Beige Powder-Coated Aluminum	10, 33	IN	13.72	12.63	4.96	LB 3.1
			CM	34.8	32.1	12.6	KG 1.4
RS004-0512	Respiratory Hygiene Station - Quartz Beige Powder-Coated Aluminum (ABS Version FD-111)	32	IN	22.25	14.75	5.00	LB 3.4
			CM	56.5	37.5	12.7	KG 1.5
RS005-0512	Respiratory Hygiene Station - Locking - Quartz Beige Powder-Coated Aluminum (ABS Version FD-112)	32	IN	22.25	14.75	5.00	LB 4.9
			CM	56.5	37.5	12.7	KG 2.2
SD-010	Surgical Apparel Organizer - Clear PETG Plastic and White ABS Plastic	60	IN	12.38	30.71	6.51	LB 5.9
			CM	31.4	78.0	16.5	KG 2.7
SN003-0212	Sign Holder for KS101-0029 & KS102-0029 Floor Stands - Quartz Beige ABS Plastic	85	IN	6.00	10.00	0.38	LB 0.5
			CM	15.2	25.4	1.0	KG 0.2
SP-003	Shoe Cover Dispenser - Clear PETG Plastic	62	IN	10.51	10.35	6.98	LB 1.1
			CM	26.7	26.3	17.7	KG 0.5
TB-003	Towel Dispenser - White Powder-Coated Steel	72	IN	11.25	15.25	3.75	LB 3.9
			CM	28.6	38.7	9.5	KG 1.7

**INDUSTRY LEADING
15 YEAR WARRANTY
ON ALL ALUMINUM &
STEEL DISPENSERS**

By driving the highest manufacturing standards possible and making our products in the USA, BOWMAN has always stood behind our dispensers. We provide an *industry leading* 15 year warranty on all aluminum and steel dispensers.

*IMPORTED

All consumable items are for demonstration purposes only and are not available for purchase through BOWMAN®.



STREAMING LIVE CONCERTS TO HOSPITALIZED KIDS

BOWMAN Dispensers is a proud sponsor of the Melodic Caring Project. The Melodic Caring Project is a registered 501(c)3 Non-Profit Organization that combines the healing properties of music with technology to stream LIVE personalized concerts to kids & teens battling serious illness at no cost to the hospital or patient. *JOIN BOWMAN. GET INVOLVED.*



www.melodiccaring.org



BOWMAN Dispensers are Proudly Made in Arlington, Washington, USA



BOWMAN Dispensers is family-owned and operated in Arlington, WA. BOWMAN began the design and manufacture of Personal Protective Equipment (PPE) storage and dispensing solutions in 1988. Since that time, the BOWMAN Dispenser product line has grown to encompass over 200 unique designs utilized in a range of markets around the world that include healthcare, food service, safety industrial, sanitation/ janitorial, and countless other markets.

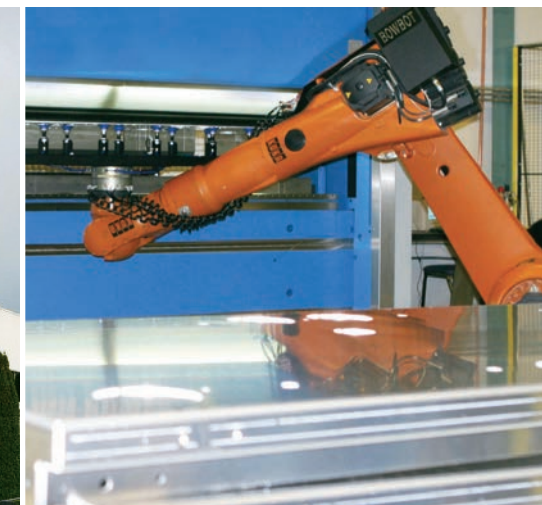

BOWMAN®



Dispensers

**ASK FOR US BY NAME.
ACCEPT NO IMITATIONS.**

THERE'S ONLY ONE GENUINE BOWMAN®

IT'S EASY TO ORDER!

Ask your distributor for BOWMAN products.

Toll Free
800.962.4660

Fax
360.435.5277

E-mail
CustomerService@BowmanDispensers.com



Connect with
BOWMAN:



**BOWMAN is
proud to sponsor
the Melodic
Caring Project:**



©2016 BOWMAN Dispensers. BOWMAN and the BOWMAN Dispensers name and logo are registered trademarks of BOWMAN. All other logos contained within belong to their respective entities and are not affiliated or in partnership with BOWMAN Dispensers. Product specifications subject to change without notification. Please confirm before ordering. C-503-0915

**MADE
IN THE USA**

*IMPORTED